

RCI 3525 Series

Electromechanical rack handle locks



The RCI 3525 series provides intelligent electronic rack handle locking and monitoring capabilities. Each model provides functionality of a manual latching system with the added benefit of electronic locking for physical and remote access control and monitoring. Integrated lock sensors provide local LED indication plus generate output signals for remote monitoring.

It can be combined with any access control device for a basic self-contained electronic access solution and high security applications with DIN lock for mechanical key override.

Plus, a Wiegand output allows a connection to a standalone or networked access control system, such as Keyscan, for remote control monitoring and reporting.





Available Models

RCI 3525	RCI 3525PRX	NEW RCI 3525iCL	NEW RCI 3525DFR
			
Electronic lock	Standard Frequency 125 kHz RFID lock	High Frequency iCLASS 13.56MHz RFID Lock	Dual frequency (125 kHz & 13.56MHz) RFID Lock
Standard electronic / mechanical rack handle lock; independent reader can be used	Electronic Locking Swinghandle features HID proximity reader for recognizing standard frequency 125kHz employee RFID credentials, including Keyscan CS125-36; HID C1325; HID C1386; HID C1391; PROXKEYIII Fob; Farpointe PSM-2PH; PSK-3H; PDT-1H	Features an iCLASS reader for recognizing high frequency 13.56 MHz employee iCLASS RFID credentials including MIFARE® Classic, MIFARE® Plus, MIFARE® DESFire	Features a dual frequency reader for recognizing both standard (125kHz) and high frequency (13.56 MHz) employee RFID credentials.

Features and benefits

- High quality and easy to install and use
- Local monitoring with multi-color LED indicator
- Wiegand output allows seamless connection with Keyscan or existing access control system
- Remote lock and unlock control
- Single or multi-point locking
- Low power, gear motor driven mechanism
- Momentary or continuous lock actuation
- High security DIN lock for mechanical key override
- Non-handed – for use with right and left-handed doors
- Wire harness and hardware kit included
- Includes three keys (keyed alike)
- Activated via Keyscan or third party access control system
- Shaft and rotation limiter are made of die-cast zinc with a bright sealer finishing
- Security integration kit module simplifies installation

Specifications

 <p>Energy: 200mA Field-Selectable 12-24VDC Typical: less than 200mA at 12VDC, max/stall: 1A, Standby: 50mA max, output signal: 100mA max load, card reader module: 60mA max)</p>	 <p>Monitoring: Lock & Handle Status</p>	 <p>Warranty: 1 Year Limited Warranty</p>
 <p>Mode: Fail-Secure</p>	 <p>PoE: Power over ethernet Friendly</p>	

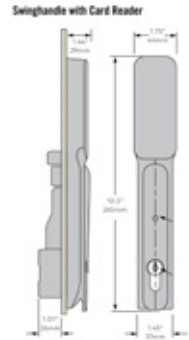

Security Integration Kit (SSIK)

This interconnect module is available and simplifies wiring between data centre racks and remote access control panels.

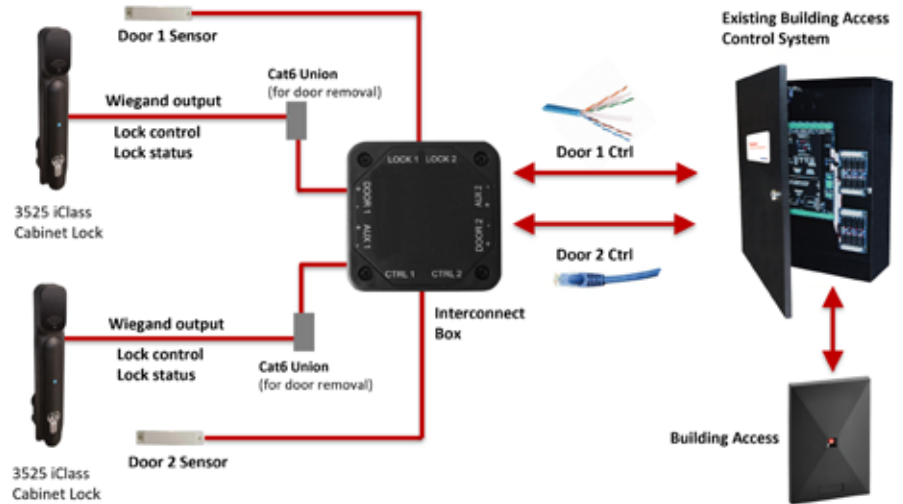

Optional Accessories

Cams

3525-GR3815	0.61" (15.5mm) grip cam, 1-1/2" (38mm) length
3525-GR3817	0.69" (17.5mm) grip cam, 1-1/2" (38mm) length
3525-GR3819	0.77" (19.5mm) grip cam, 1-1/2" (38mm) length
3525-GR3821	0.85" (21.5mm) grip cam, 1-1/2" (38mm) length
3525-GR3823	0.93" (23.5mm) grip cam, 1-1/2" (38mm) length
3525-GR4522	0.77" (19.5mm) grip cam, 1-3/4" (45mm) length
3525-GR4524	0.85" (21.5mm) grip cam, 1-3/4" (45mm) length
3525-GR4526	0.93" (23.5mm) grip cam, 1-3/4" (45mm) length

Gearbox For Multi-Point Systems

3525-MPLH	Left Hand Gearbox (CCW to open)
3525-MPRH	Right Hand Gearbox (CW to open)

Integration Kit

SSIK	Security Integration Kit
------	--------------------------

Copyright © 2022 dormakaba Inc. Information on this sheet is intended for general use only. dormakaba reserves the right to alter designs and specifications without notice or obligation.

dormakaba Canada Inc.
7301 Decarie Blvd
Montreal, Quebec H4P 2G7
1 888 539-7226

sales_RCI@dormakaba.com
dormakaba.us