

# MUTO Comfort Teleskop Anlagenansicht 2-flügelig / Wandmontage Schließkante anschlagend

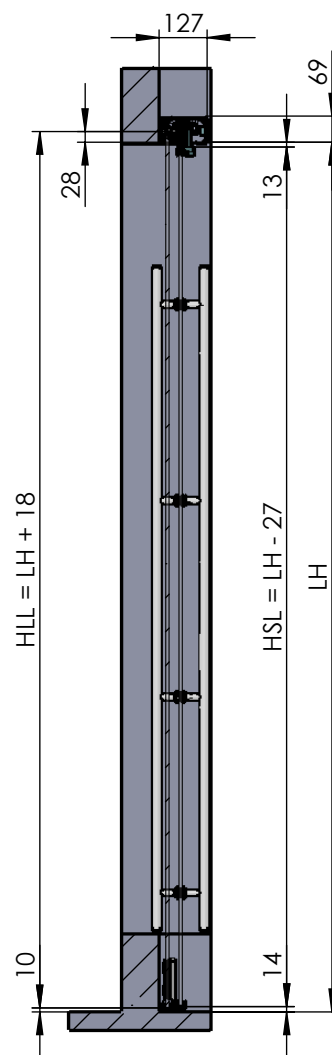
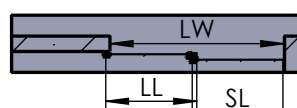
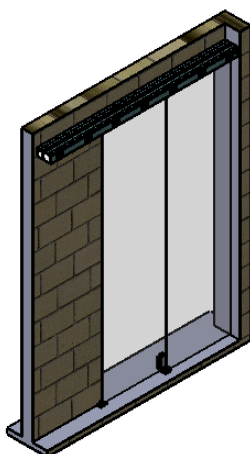
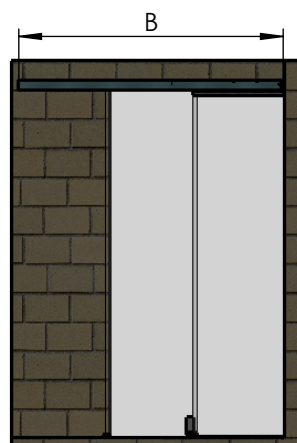
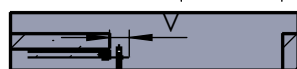
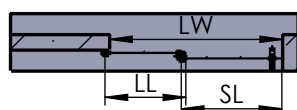
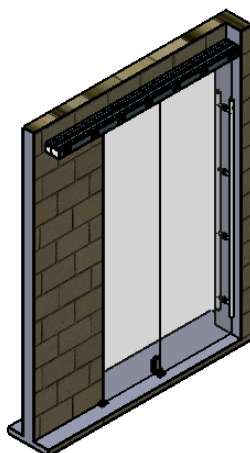
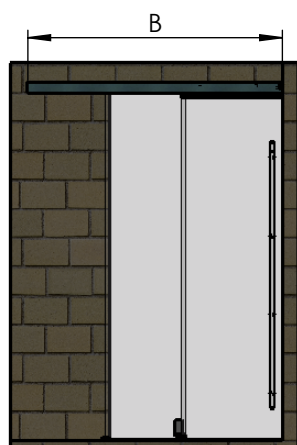

max. Flügelgewicht	2x 80kg
max. Flügelhöhe	3000mm
Glasdicke/Glasart	8-13,5mm ESG/VSG

		Glasbreite SL ohne Griffstange	Glasbreite LL ohne Griffstange	Glasbreite SL mit Griffstange	Glasbreite LL mit Griffstange
ohne Dormotion	min.	600	600	665	535
	max.	1200	1200	1265	1135
mit Dormotion	min.	790	790	855	725
	max.	1200	1200	1265	1135
		Laufschielenlänge B ohne Griffstange	Lichte Weite LW ohne Griffstange	Laufschielenlänge B mit Griffstange	Lichte Weite LW mit Griffstange
ohne Dormotion	min.	1748	1145	1683	1145
	max.	3548	2345	3483	2345
mit Dormotion	min.	2318	1525	2253	1525
	max.	3548	2345	3483	2345
Gesamtlänge Laufschiene incl. Stirnabdeckung = Laufschielenlänge B + 2 x 2mm					

# MUTO Comfort Telescopic layout view 2 panel / fixed at wall installation with 90° stop

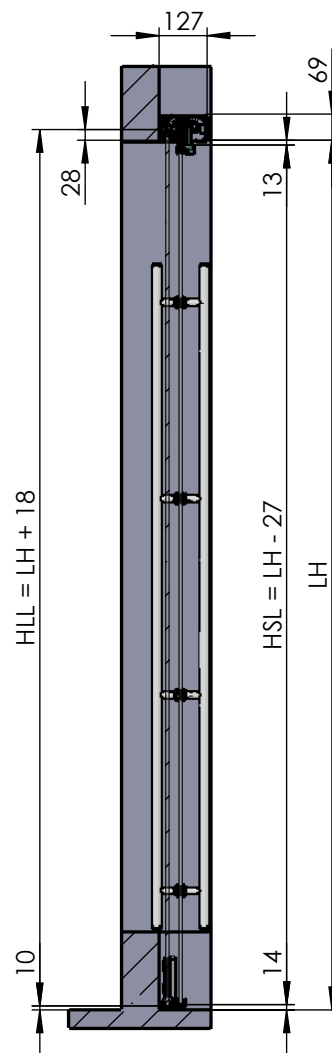
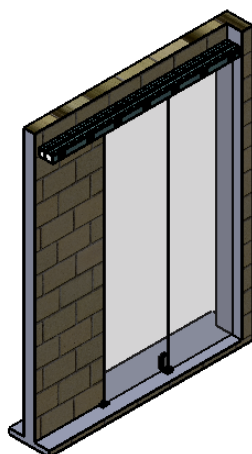
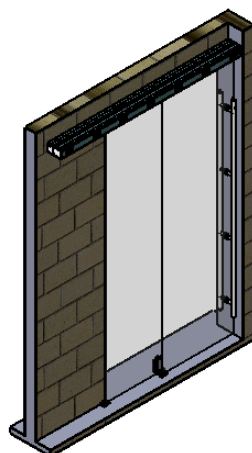
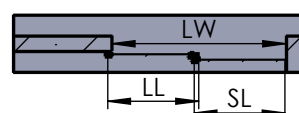
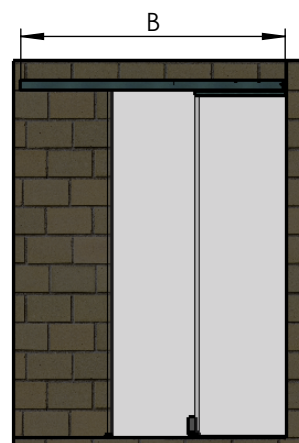
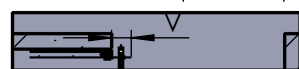
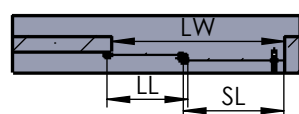
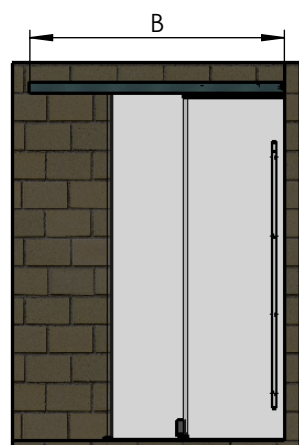

max. panel weight	2x 80kg
max. panel height	3000mm
glass thickness/type	8-13,5mm TSG/LSG

		glass width QM without handle bar	glass width SM without handle bar	glass width QM with handle bar	glass width SM with handle bar
without Dormotion	min.	600	600	665	535
	max.	1200	1200	1265	1135
with Dormotion	min.	790	790	855	725
	max.	1200	1200	1265	1135
		profile length B without handle bar	light opening LW without handle bar	profile length B with handle bar	light opening LW with handle bar
without Dormotion	min.	1748	1145	1683	1145
	max.	3548	2345	3483	2345
with Dormotion	min.	2318	1525	2253	1525
	max.	3548	2345	3483	2345
		total profile length incl. End caps = profile length B + 2 x 2mm			