

ED900

Low Energy Swing Door Operator
(Fine cover)

Owner's Manual

08125360 – 02-2020

| EN |

dormakaba 

Table of contents

Table of contents	2
1 General information	3
2 To our customers	4
3 What you should know	4
3.1 Distributor information	4
3.2 Knowing act	4
3.3 Program switches	5
3.4 Optional key switch panels	5
4 AAADM Safety information labels	6
4.1 Safety information labels, low energy power operated doors	6
5 Daily safety check procedures	7
5.1 Low energy power operated swing doors	7
6 ED900 door signage	8
6.1 Low energy operator	8
6.2 Door signage, low energy single swing door	8
6.3 Door signage, low energy double swing doors	9
7 ED900 cleaning	10
7.1 ED900 environment and cleaning	10

1 General information

1.1 Owner's Manual

This Owner's Manual applies to the dormakaba ED900 low energy swing door system.

1.2 Manual storage

This document must be kept in a secure place, and accessible for reference as required.
If the door system should be transferred to another facility, insure that this document is transferred as well.

1.3 dormakaba.com website

Manuals are available for review, download, and printing on dormakaba.com website.

1.4 Dimensions

Unless otherwise specified, all dimensions are given in inches (").

1.5 Symbols used in this manual.



WARNING

This symbol warns of hazards which could result in personal injury or threat to health.

1.6 ED900 operator with fine cover.

Fig.1.1 ED900 fine cover

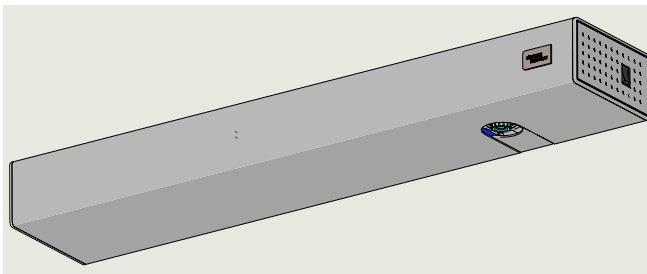
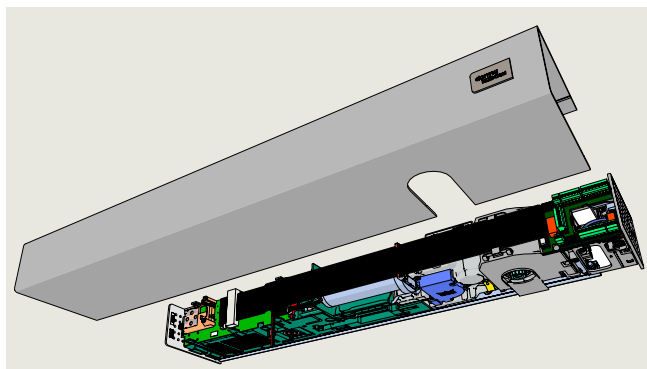

Fig.1.2 ED900 fine cover removed from operator



2 To our customers

We are pleased that a dormakaba ED900 low energy swing door system has been selected for this installation.

dormakaba designed, tested and built the system to provide many years of service.

The purpose of this manual is to familiarize you with your ED900 low energy swing door system.

It is essential that you "know your system" and that you recognize the importance of maintaining your door system in compliance with industry standards for safety.

It is your responsibility as owner and caretaker of the equipment, to inspect the operation of your door system on a daily basis as outlined in Chapter 5, Daily Safety Check Procedures to insure that it is safe for use by your customers and employees.



WARNING

Should the door fail to operate as prescribed in the Safety information checklist or at any other time for any reason, do not attempt to repair or adjust the ED900 low energy swing door system!

Call your local authorized dormakaba USA, Inc. distributor for repair. The distributor's AAADM certified technicians are trained to service the ED900 swing door system using the dormakaba USA, Inc. Installation Manual, and in accordance with applicable industry standards.

2.1 Service availability.

dormakaba USA, Inc. has a nationwide network of authorized distributors for sales, installation and service of its products.

2.2 Compliance with industry standards for safety.

Your ED900 low energy swing door system was designed to the latest operating and safety standards. In order to insure the continued safe operation of the door, it is important that:

- Proper decals and labels be applied and maintained on your doors (Chapter 6).
- If decals and labels have been removed, or cannot be read, contact your local authorized dormakaba USA, Inc. distributor for replacement decals or labels.

3 What you should know

1. dormakaba ED900 Owner's Manual content.
2. Daily Safety information checklist (Chapter 4).
3. Instructions on how to conduct the daily Safety Information checklist by walk through example (Chapter 5).
4. Annual compliance inspection label completion (Chapter 4).
5. Circuit breaker or disconnect location for 115 Vac power to the ED900.
6. Program and Exit switch location and instructions in their use. (Para. 3.3).
7. Discussion of problems that could result from operator being allowed to operate after a malfunction observed.
8. Call Technical Services 1-800-523-8483 for service or questions about your system if you are uncertain of any condition or situation.



WARNING

If there are any problems, discontinue door operation immediately and secure the door in a safe manner.

3.2 Knowing act

3.2.1 Knowing act:

ANSI/BHMA standard A159.19 definition.

Any conscious action with the expected result of opening a door. This includes but is not limited to::

- Wall or jamb mounted contact or non contact switches such as push plates.
- The action of manually opening (pushing or pulling) a door.
- Controlled access devices such as keypads, card readers, and key switches.

3.3 Program and Exit Only switches

3.3.1 Program switch control modes.

- **Auto**, door opens following pulse generation by a knowing act device or push/pull.
- Door will close after hold open time (adjustable) has expired.
- Knowing act device, Para. 3.2. Door will remain at full open position for not less than five seconds.
- Push/pull actuation of door, Para. 6.2. Door will remain at full open position for not less than three seconds.

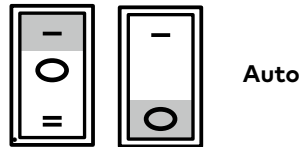

- **Open**, door opens automatically and remains open.

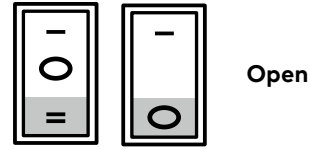

- **Close**, door closes automatically, or remains closed.

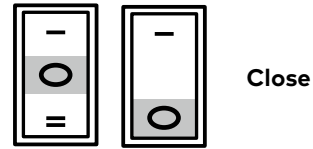

3.3.2 Exit only switch.

- Disables exterior switch only.

Fig. 3.3.1 Program and Exit Only switches

- 1 Exit Only switch, 2 position
- 2 Program switch, 3 position

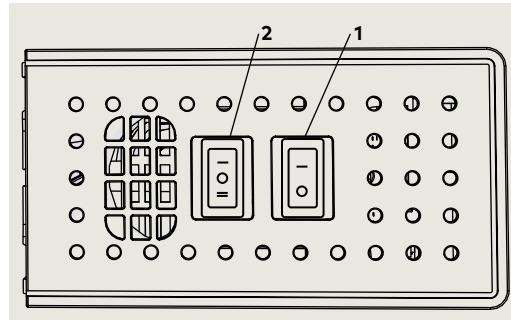

3.4 Optional key switch panels

Fig. 3.4.1 Optional key switch panels

- 1 Program switch, three position
- 2 Exit only switch, two position
- 3 Service connector

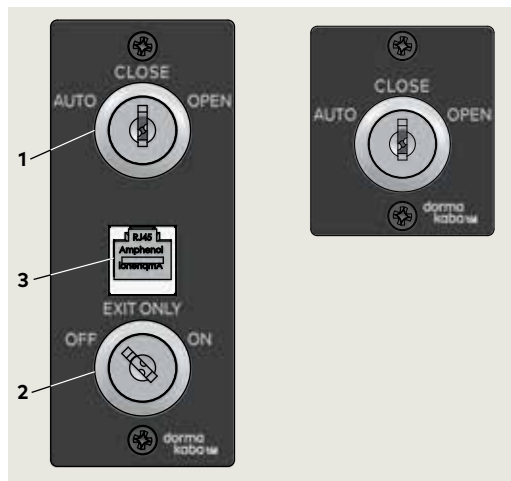

4 AAADM Safety information labels

4.1 Safety information labels, low energy power operated doors

4.1.1 Low energy swing door safety information label.

This AAADM label outlines safety checks that should be performed daily on swing door controlled by an ED900 low energy operator.

4.1.2 Safety information label location.

Place label in a protected, visible location on door frame, near program switch panel if possible.

4.1.3 Annual compliance section of label.

This section of label is only completed on low energy swing doors that comply with ANSI/BHMA A156.19 standard and pass inspection by a AAADM certified dormakaba USA, Inc. technician.

4.1.4 Additional annual compliance inspection labels.

Place additional labels over annual compliance inspection section of safety information label.

Fig. 4.1.1 Safety Information and Annual Compliance Inspection labels

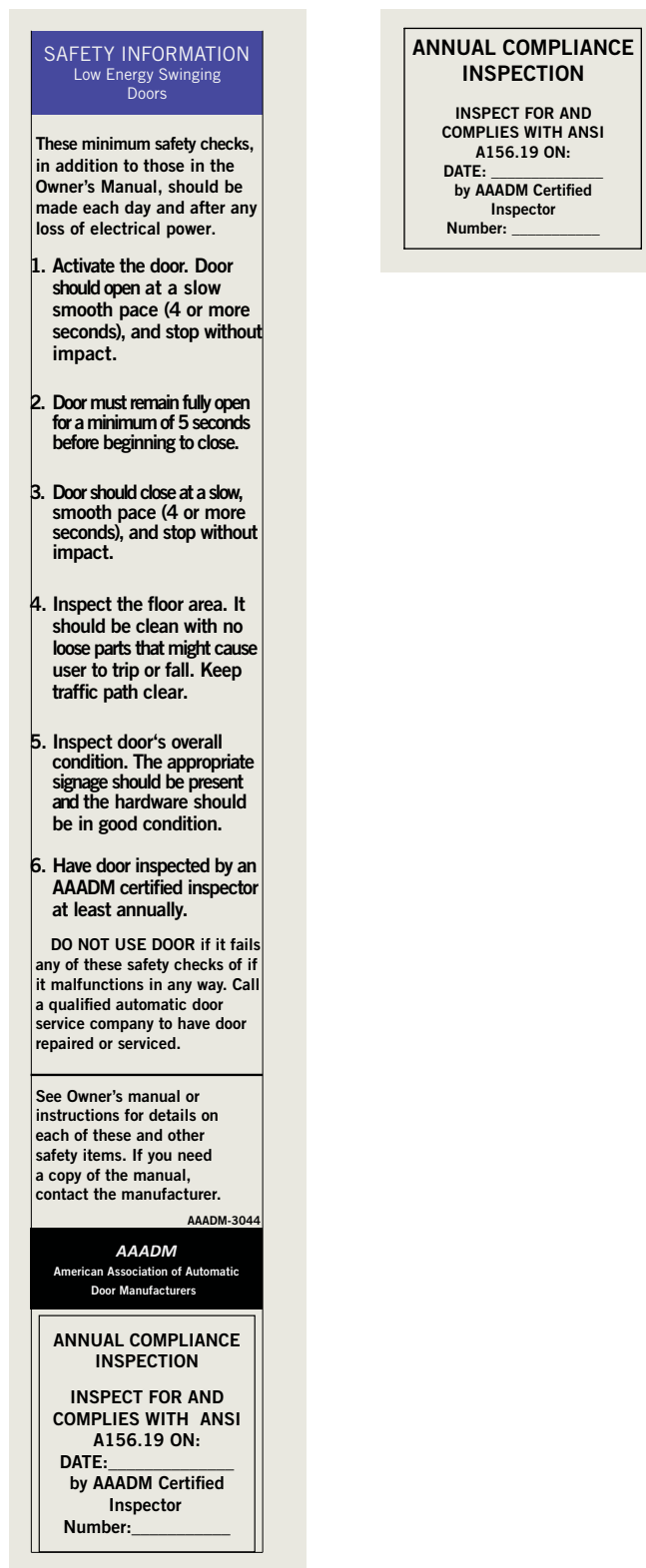

5 Daily safety check procedures

5.1 Low energy power operated swing doors

5.2.1 Performing daily safety checks.

Perform safety checks daily on your low energy swing door to insure your customer and employee safety. These daily safety checks are also listed in Chapter 4, Safety Information labels, low energy swinging doors.

1. Activate the door by a knowing act (Para.3.2).
 - Door should open at a slow smooth pace (4 seconds or more) and stop without impact.
2. Door must remain fully open for a minimum of 5 seconds before beginning to close.
 - Door should close at a slow smooth pace (4 seconds or more) and stop without impact.
3. Inspect the floor area, it should be kept clean with no loose parts that might cause user to trip or fall. Keep traffic path clear.
4. Inspect door's overall condition. The appropriate signage should be present and all hardware should be in good condition.
5. Have door inspected by a dormakaba USA Inc. AAADM certified technician annually, at a minimum.



WARNING

If there are any problems, discontinue door operation immediately and secure the door in a safe manner.

Call your local dormakaba USA, Inc. distributor for repair.

5.2.2 Review safety related items and perform checks periodically as noted.



TIPS AND RECOMMENDATIONS

Perform these checks while traffic is restricted.

1. Housekeeping
 - Check door area for tripping or slipping hazards.
 - Make sure all hardware and overhead covers are properly secured.
 - There should be no bulletin boards, literature racks, merchandise displays, or other attractions in the door area that would interfere with the use of the door or encourage people to stop and stand in the door area.
2. Check all doors for damage.
3. Force
 - Force to prevent the door from closing should not exceed 15 pounds measured with a force gauge.
4. Door safety signage
 - Refer to Chapter 6 for door safety signage requirements.
5. Lock stile
 - With door open, grasp lock stile of door and attempt to move horizontally and vertically.
 - There should be no looseness in the door pivots or in connections between door and operator.
6. Breakout stop
 - Center pivoted in swinging doors may be supplied with an emergency breakout stop or switch that will allow the door to open in the direction of emergency egress.
 - When the door is pushed into the breakout mode, check that the door will not activate.



WARNING

If there are any problems, discontinue door operation immediately and secure the door in a safe manner.

Call your local dormakaba USA, Inc. distributor for repair.

6 ED900 door signage

6.1 Low energy operator

6.1.1 Overview

Signage and warnings are specified in ANSI /BHMA A156.19, American National Standard for Power Assist and Low Energy Power Operated Doors.

6.1.2 All low energy doors.

1. AUTOMATIC CAUTION DOOR decal.
 - All low energy doors shall be marked with signage visible from both side of door with the words "AUTOMATIC CAUTION DOOR".
 - Signs shall be mounted 50" ± 12" from floor to centerline of sign.

6.1.3 Knowing act device.

1. ACTIVATE SWITCH TO OPERATE decal.
 - When a knowing act device is used to initiate operation of door operator, door shall be provided with sign on each side of door where switch is operated with message "ACTIVATE SWITCH TO OPERATE"

6.1.4 Push/Pull to operate door.

1. PUSH TO OPERATE, PULL TO OPERATE decals.
 - When push/pull is used to initiate operation of door operator, doors shall be provided with the message "PUSH TO OPERATE" on push side of door and "PULL TO OPERATE" on pull side of door.

Fig. 6.1.1 AUTOMATIC CAUTION DOOR decal

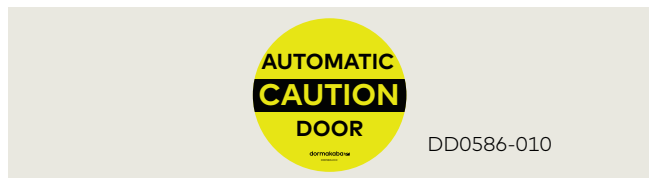

DD0586-010

Fig. 6.1.2 ACTIVATE SWITCH TO OPERATE decal

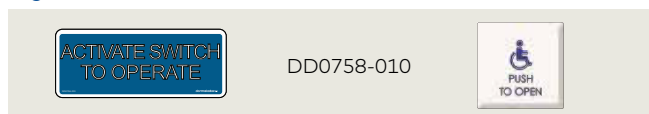

DD0758-010

Fig. 6.1.3 PUSH / PULL TO OPERATE decals

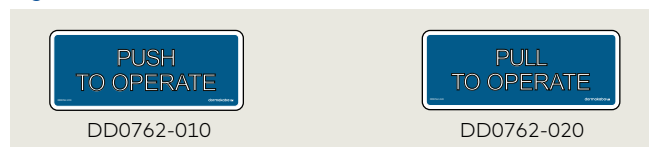

DD0762-010

DD0762-020

6.2 Door signage, low energy single swing door

Fig. 6.2.1 Knowing act device initiation of door operation

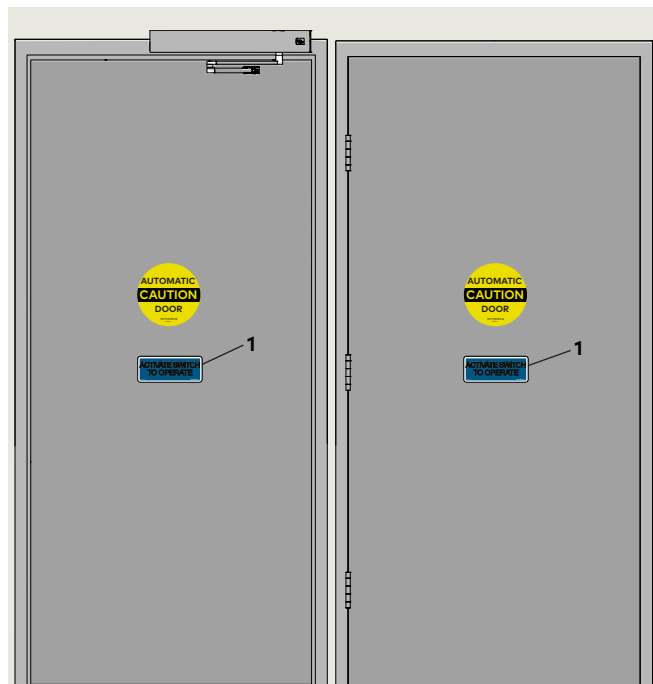

1 Activate Switch to Operate DD0758-010

Fig. 6.2.2 Push / Pull initiation of door operation
Push to Operate Pull to Operate

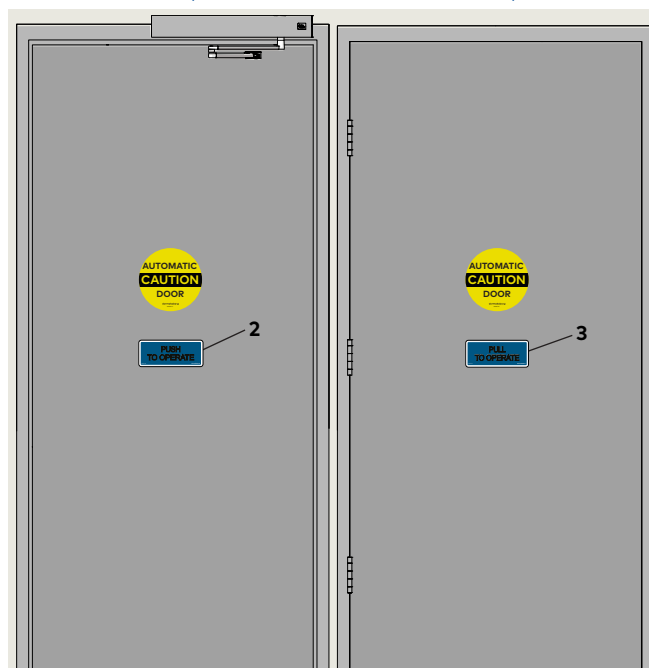

2 Push to Operate DD0762-010

3 Pull to Operate DD0762-020

6.3 Door signage, low energy double swing doors

Fig. 6.3.1 Knowing act, non-hinge side

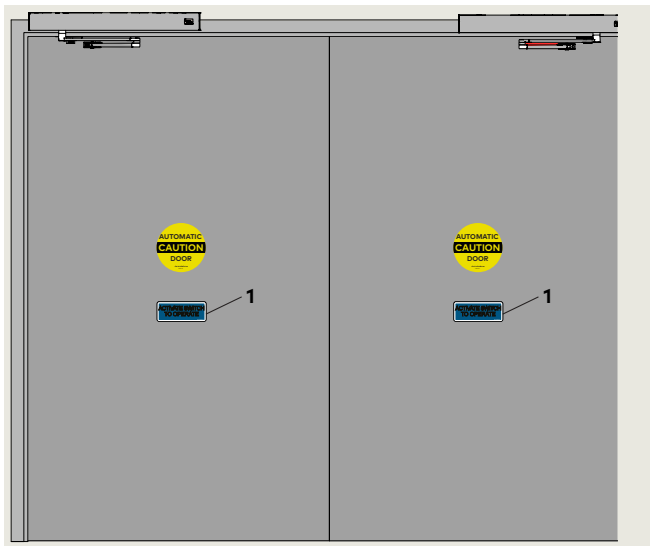

Fig. 6.3.4 Knowing act, non-hinge side

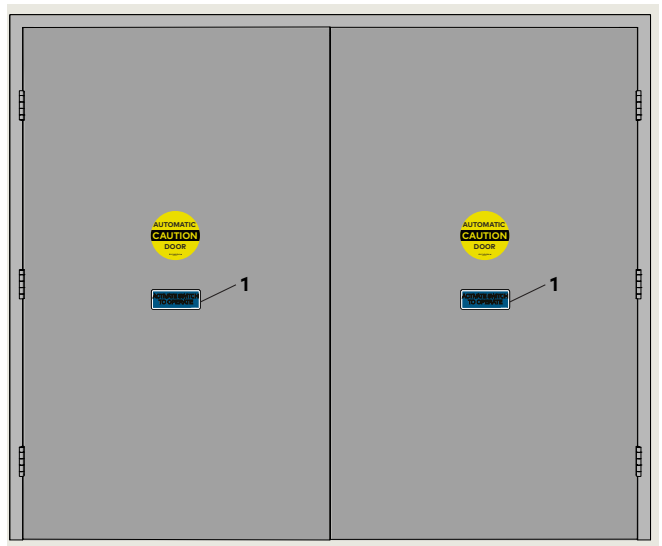

Fig. 6.3.2 Push / Pull, push to operate

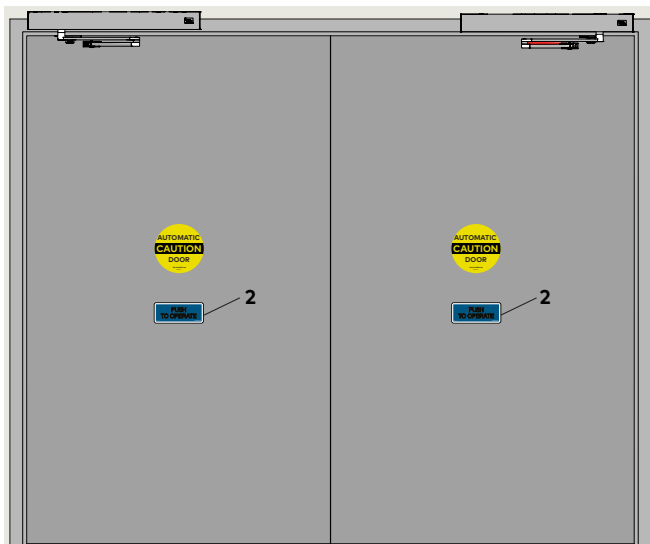

Fig. 6.3.5 Push / Pull, pull to operate

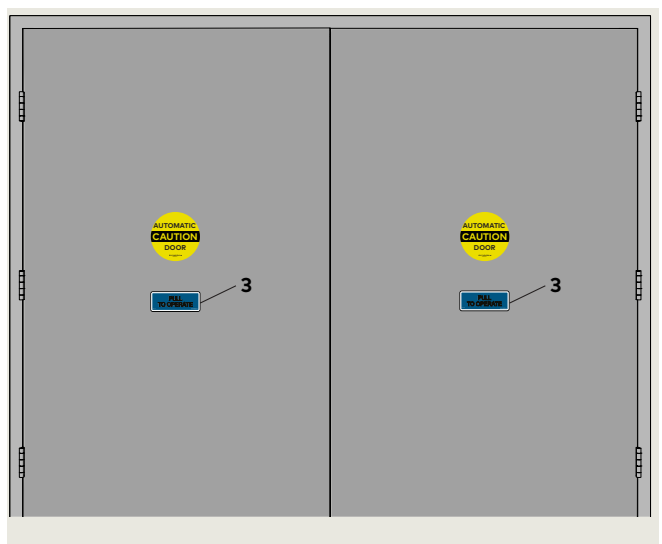

Fig. 6.3.3 Double egress, knowing act

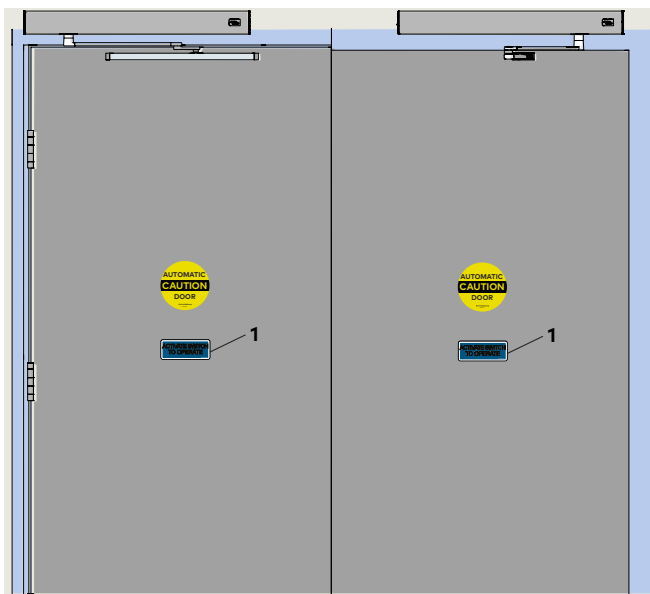
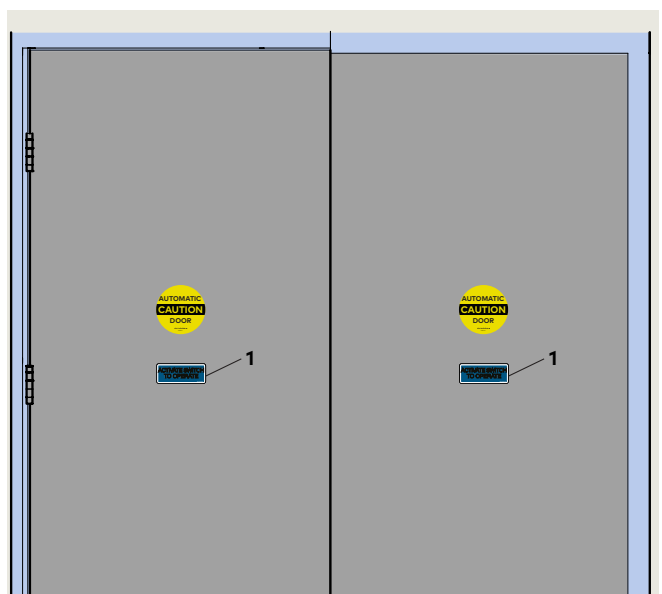

Fig. 6.3.6 Double egress, knowing act



7 ED900 cleaning

7.1 ED900 environment and cleaning

Table 7.1.1 Operator environmental requirements.

Ambient temperature	5 to 122 °F
---------------------	-------------

Fig. 7.1.1 ED900 with fine cover

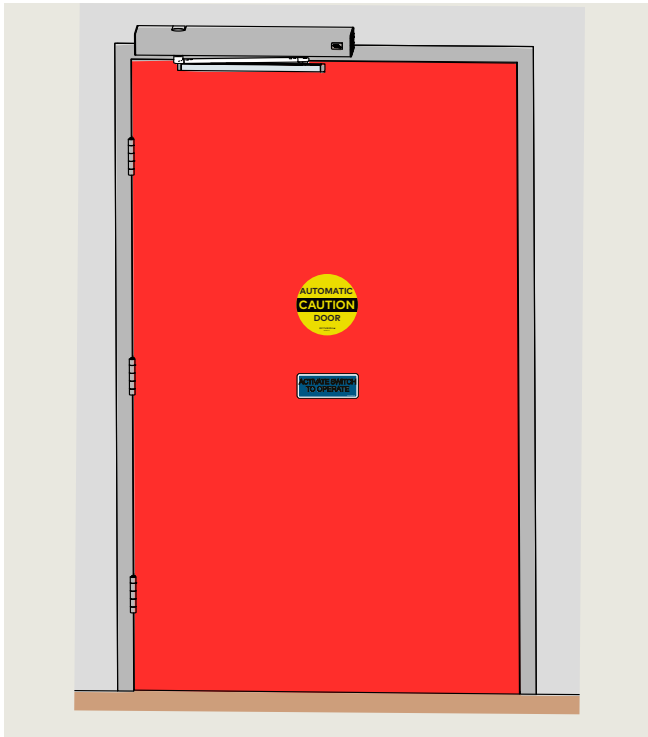

7.1.1 ED900 environmental requirements.

ED900 with fine cover is designed to operate on an interior building application under the specifications shown in Table 7.1.1.

7.1.2 Areas around door(s) and door swing radius.

Areas around doors and door swing radius must be kept clear of all obstacles.

7.1.3 Cleaning



WARNING

Cleaning of fine cover surfaces must be done with program switch (Para. 3.3) in Close position!

Fine cover surface can be cleaned with a damp cloth and commercial cleaning agents.



TIPS AND RECOMMENDATIONS

Abrasive (scouring) agents should not be used as they may damage external surfaces.

7.1.4 Water and other liquids.

CAUTION

No water or other liquids must be sprayed or spilled on ED900 fine cover!

This page left intentionally blank.

