

WN 058036 45532  
07/10

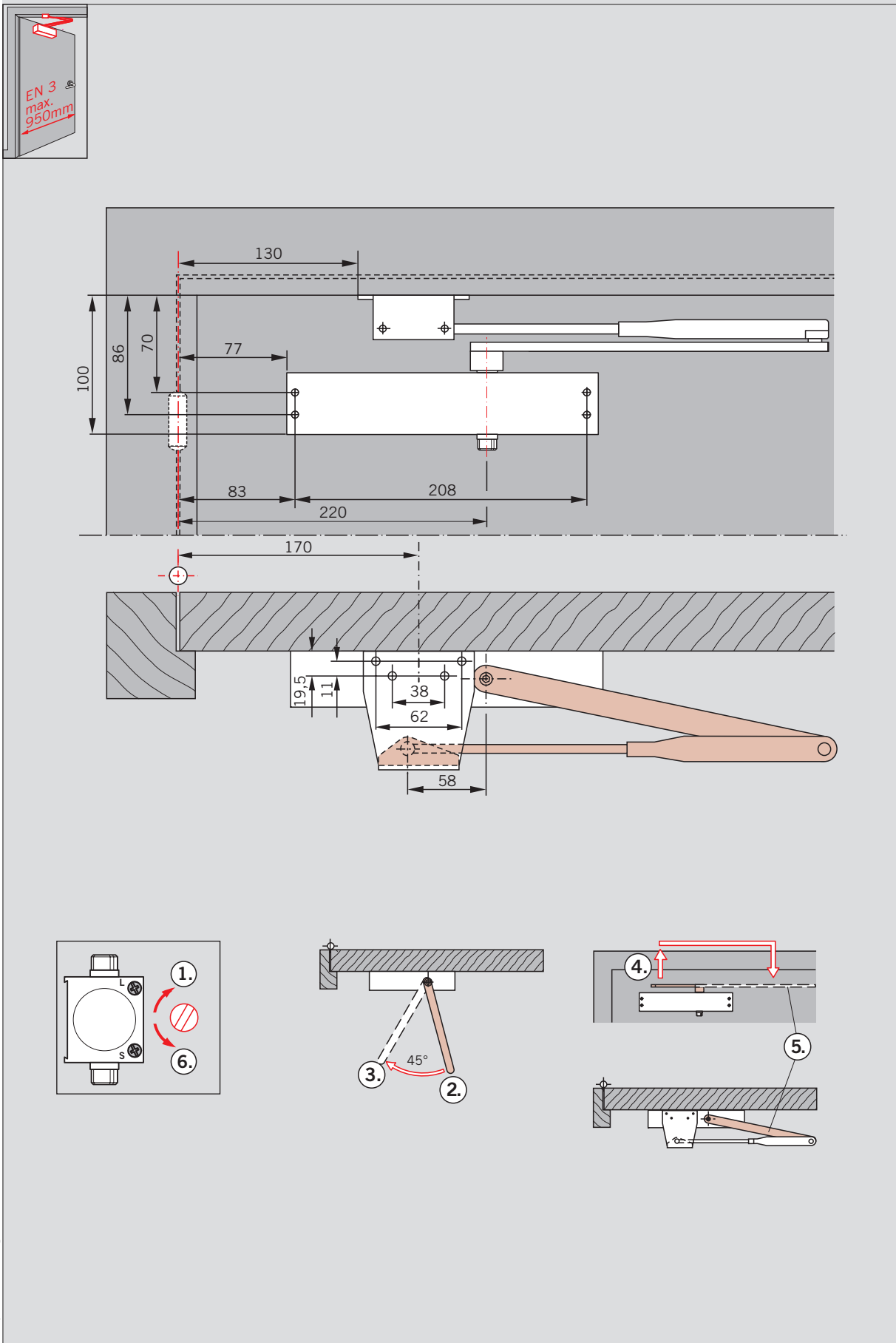

Änderungen vorbehalten  
Subject to change without notice