

WN 056379 45632
11/08

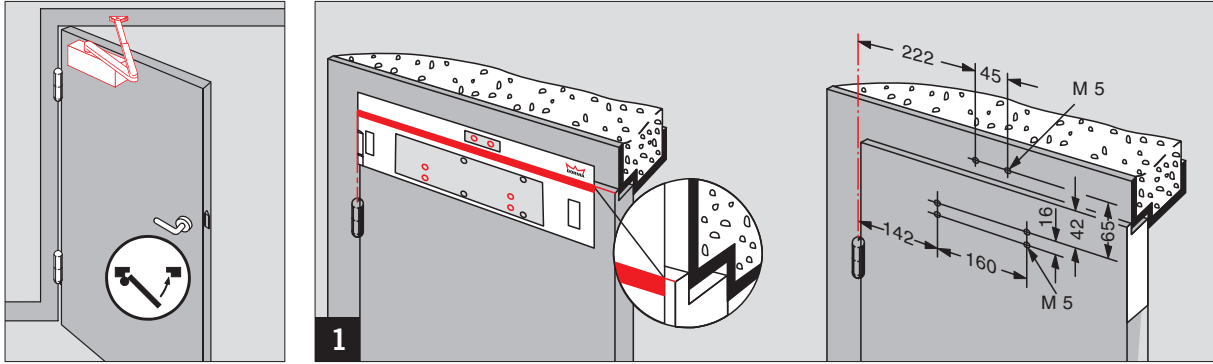

CE	DORMA GmbH + Co. KG Postfach 4009 58 247 Ennepetal	0432 - BPR-0007	EN 1154:1996+A1:2002	4	8	3	1	1	4
				4	8	3	1	1	4
Dangerous substances: None									

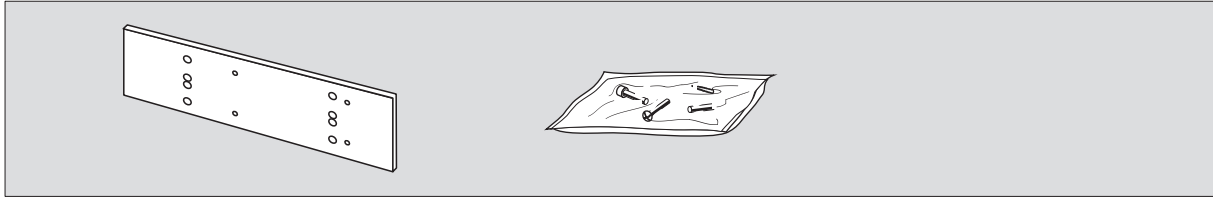

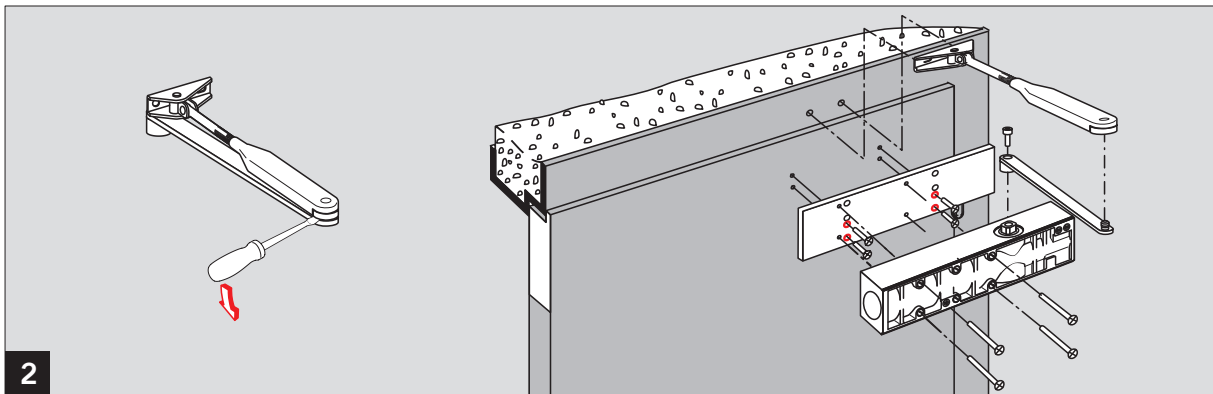
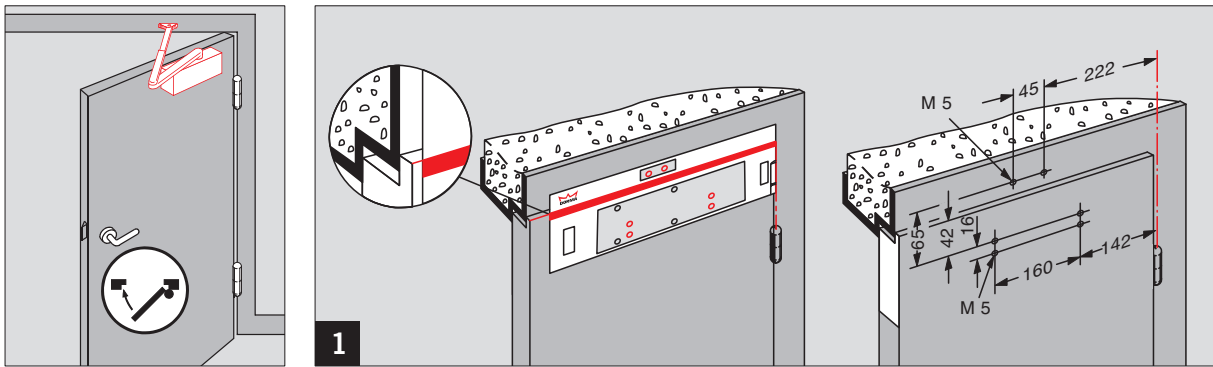
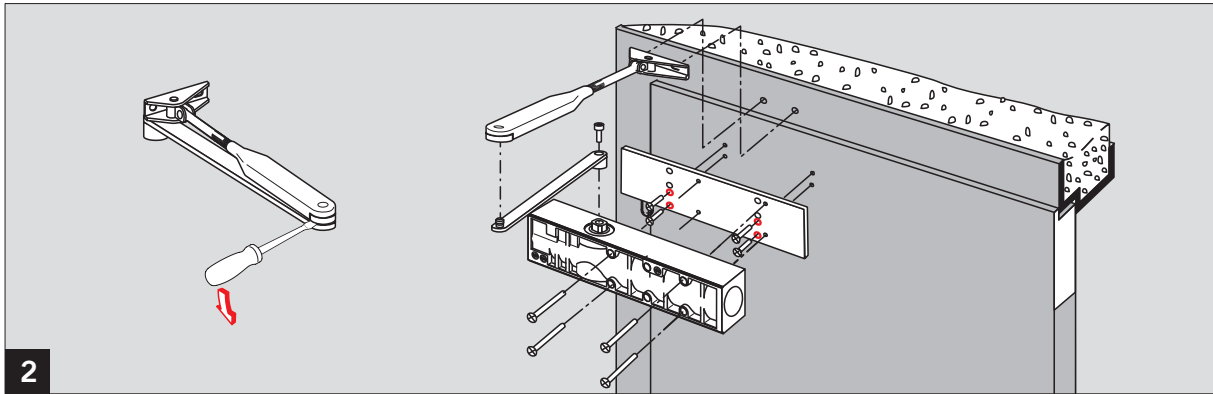
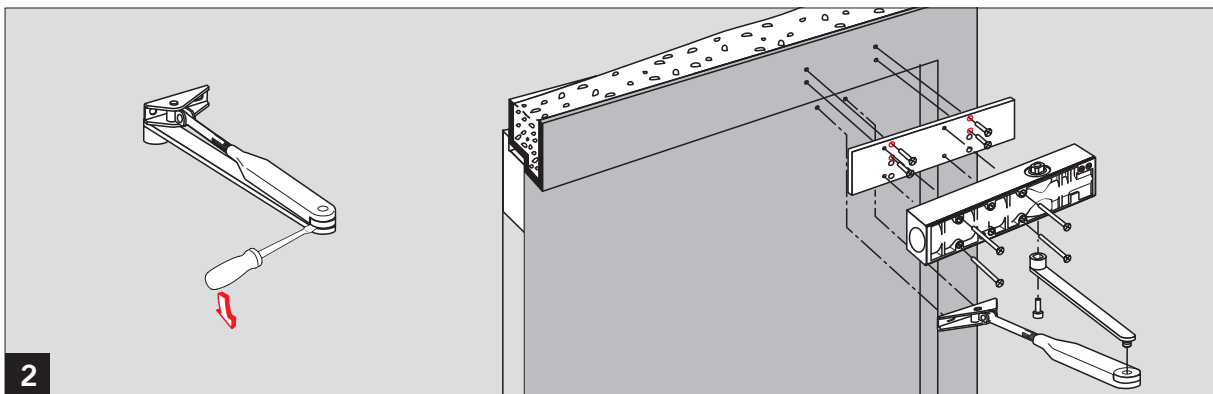
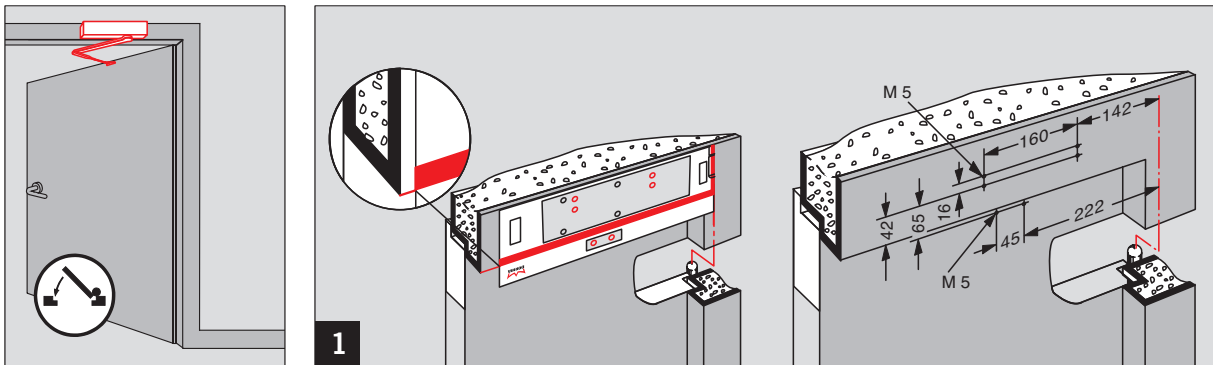
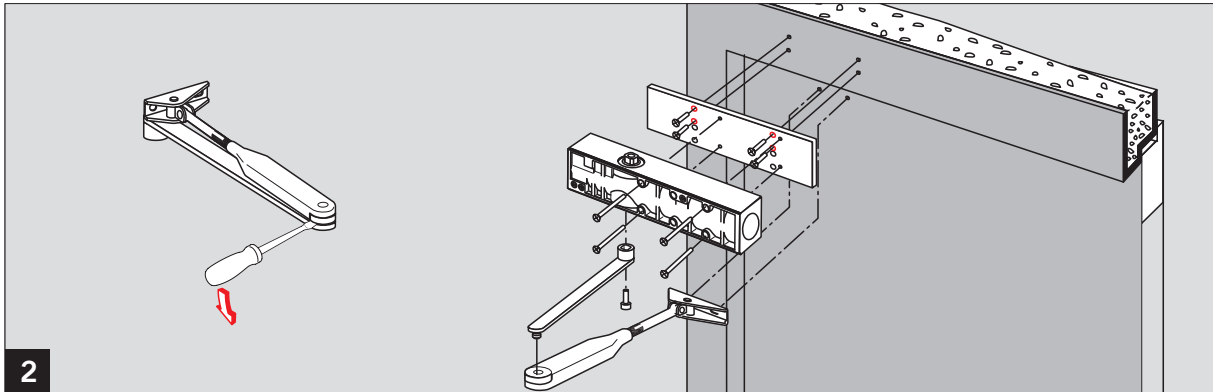
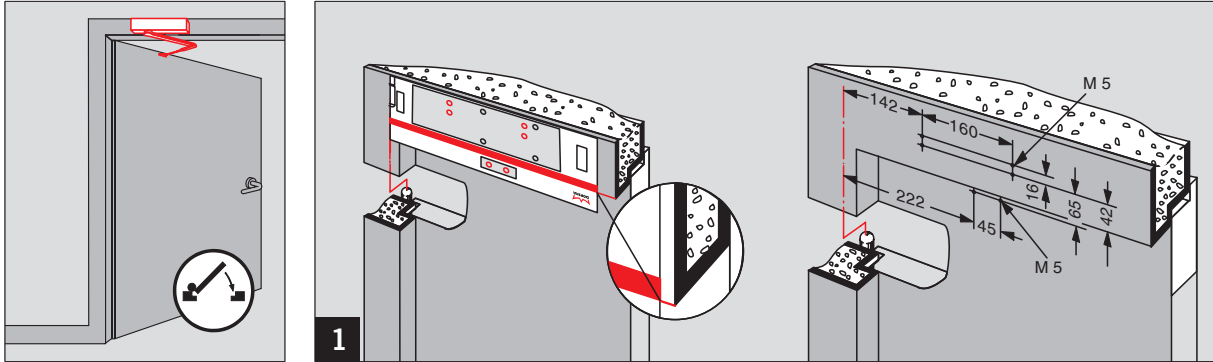
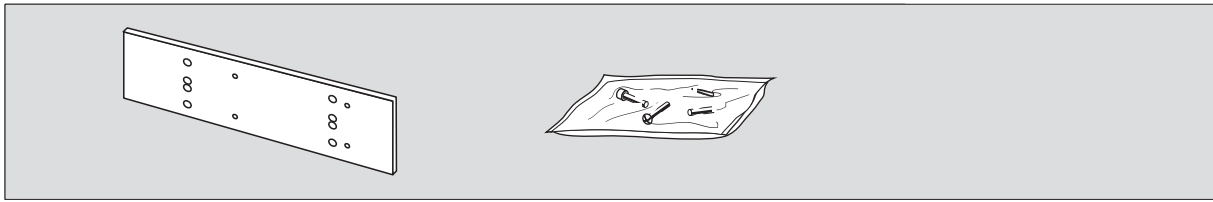

Änderungen vorbehalten
Subject to change without notice