

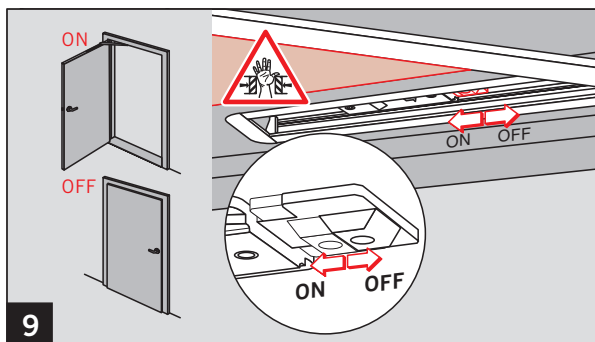

WN 056309 45532
02/12

Art. Nr.52003600

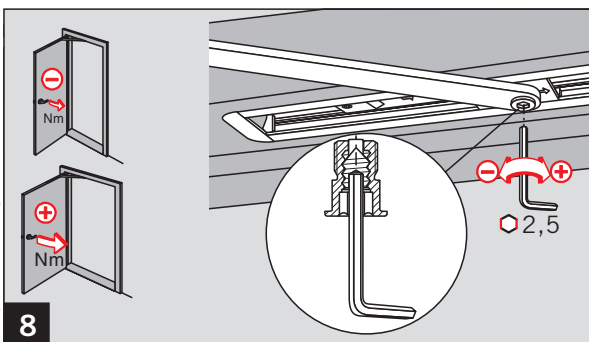
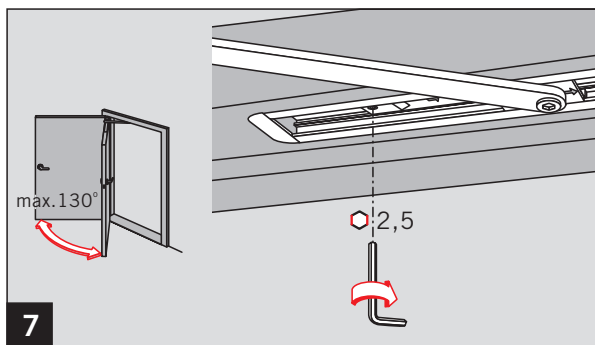
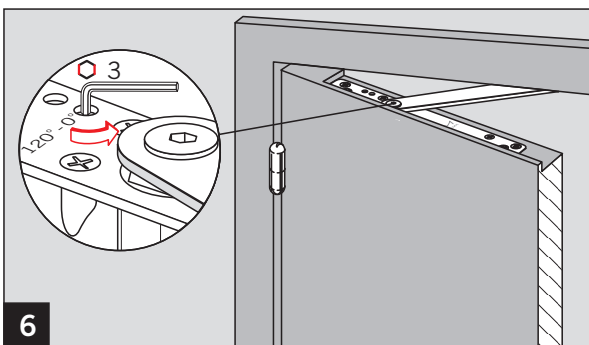
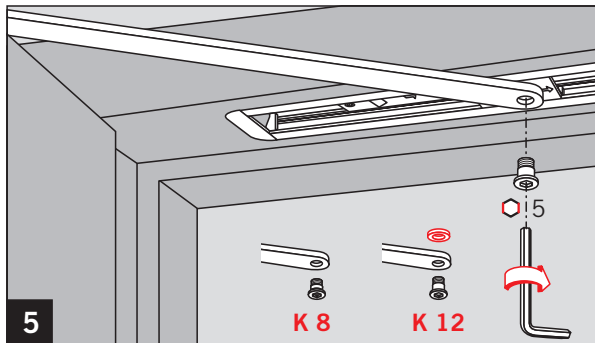
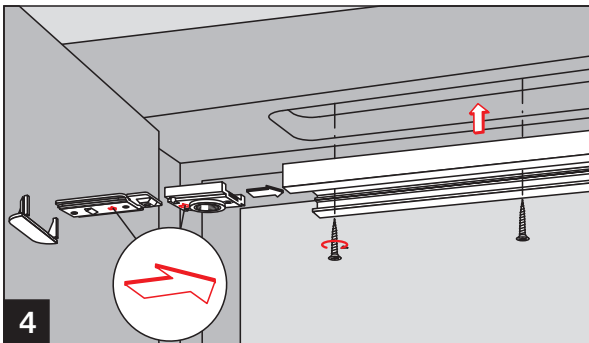
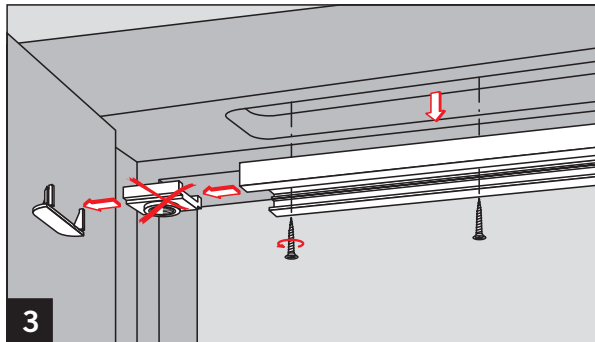
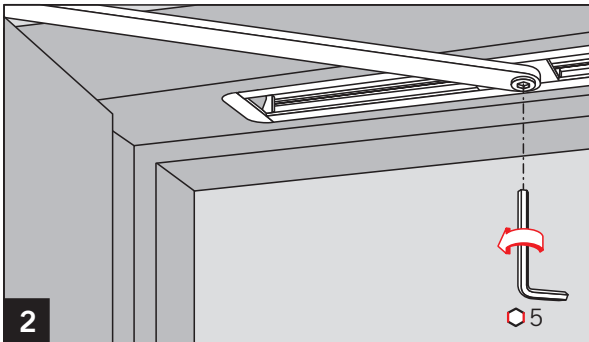
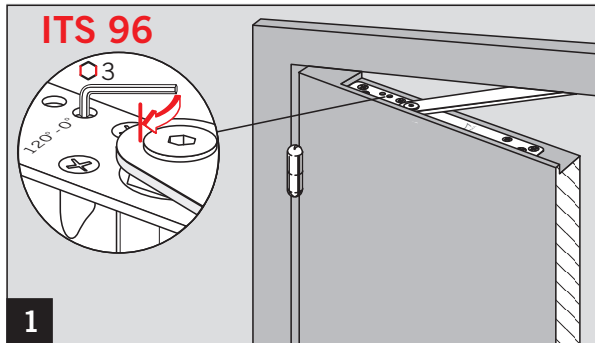
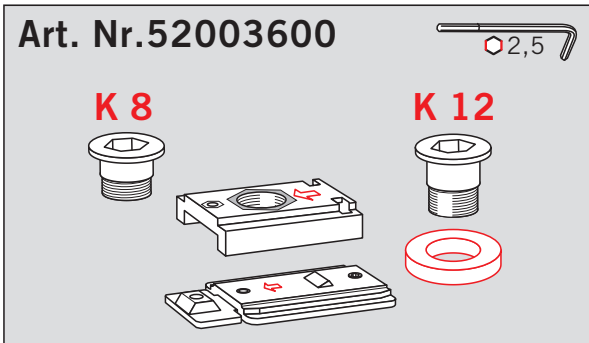

Änderungen vorbehalten
Subject to change without notice