

WN 056537 45632
09/06

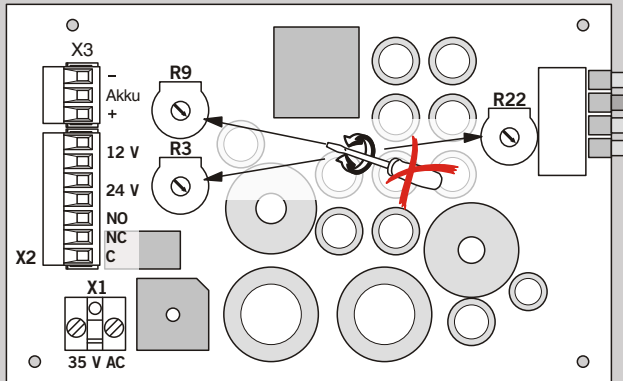
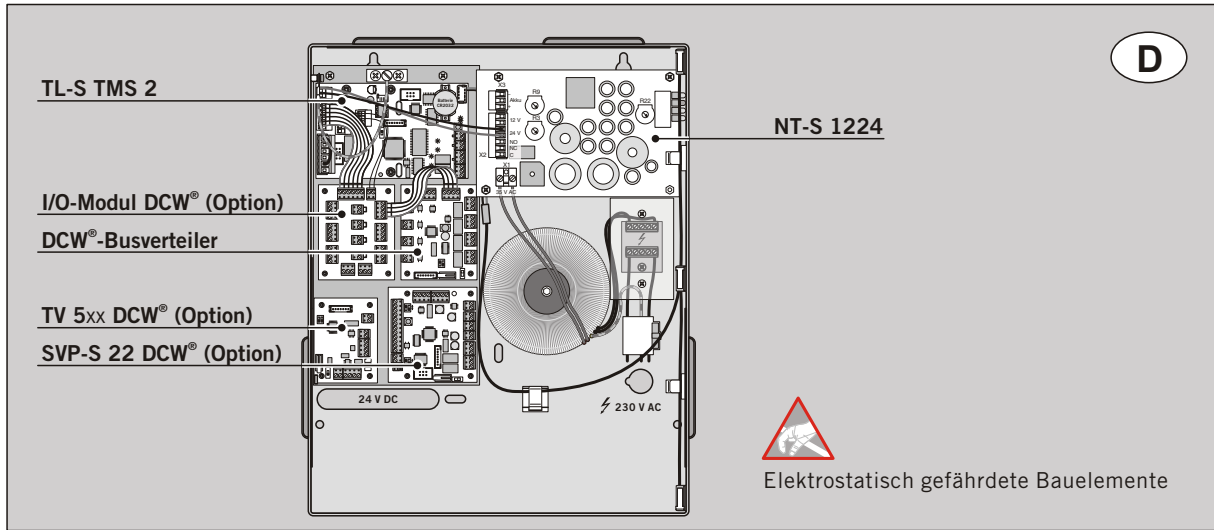

Technische Daten:

Versorgungsspannung: 35 V AC, +/- 10%
 Nennstromaufnahme: ca. 100 VA
 max. Ausgangsstrom (24 VDC): 1,5 A
 max. Ausgangsstrom (12 VDC): 1,0 A
 Trafo absichern mit: T 1 A

Beschaltung NT-S 1224

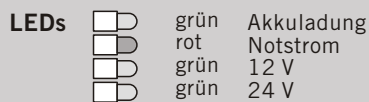
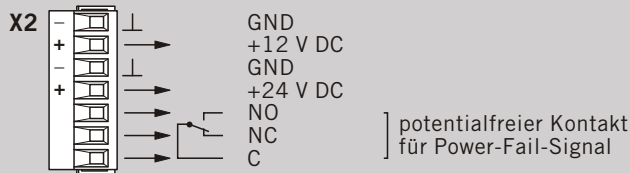

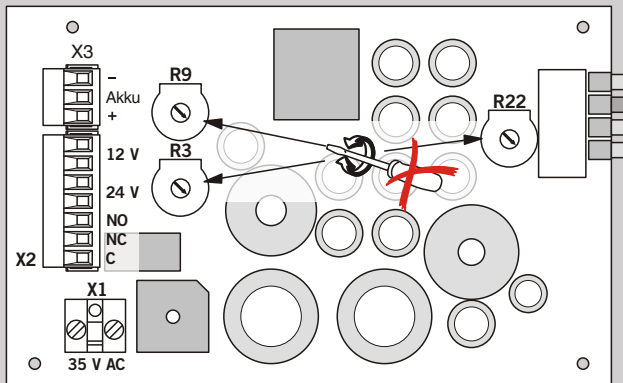
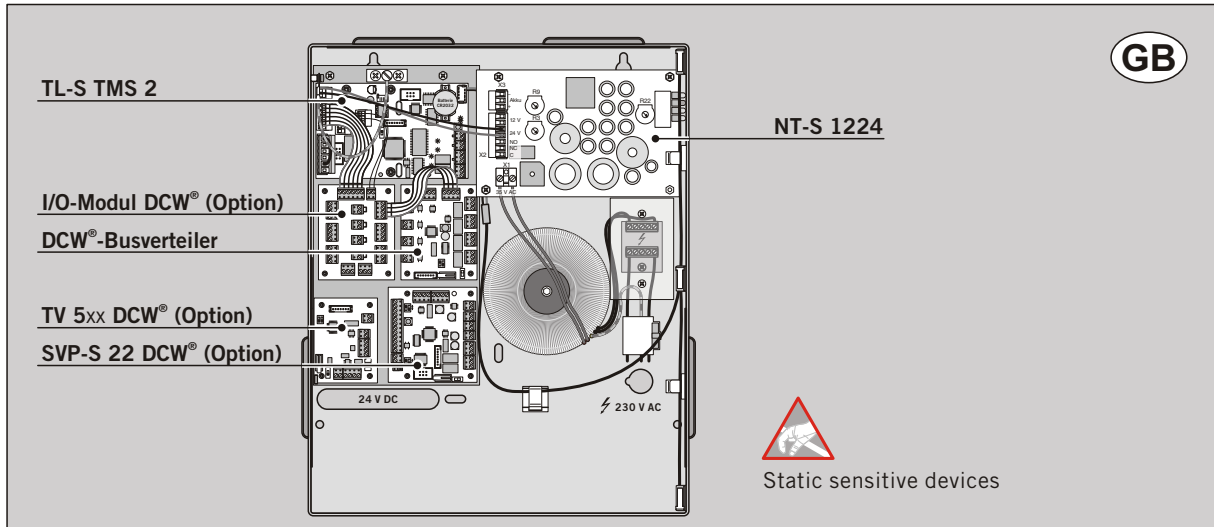

Technical data:

Power supply: 35 v AC, +/- 10%

Current input: approx. 100 VA

Current output max. (24 v DC): 1,5 A

Current output max. (12 v DC): 1,0 A

Protect transformer with fuse: T 1 A

Terminal connections NT-S 1224

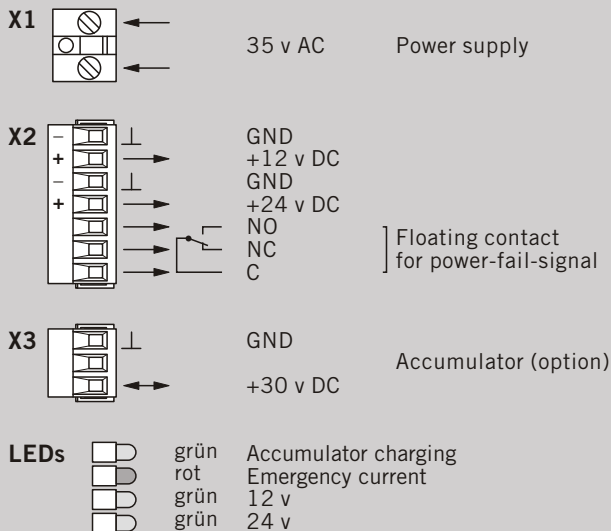

Änderungen vorbehalten
Subject to change without notice