



BEYOND SECURITY

KABA[®]

Panic Exit Devices

ED22 Series, ED2227 Series, ED22M Series,
Accessories and Parts



Panic Exit Devices

Kaba Panic Exit Devices provide a fast and convenient means of escape in the case of an emergency. Models are available in rim exit and vertical rod devices for single doors as well as vertical rod devices for double doors.





INDEX

Panic Exit Devices

- 2 Finishes and handing
- 3 Usage chart
- 4-5 Dimensions

ED22 Series

- 6 ED22 Series details and dimensions
- 7 ED22 Product specifications
- 8 ED22 functions

ED2227 Series

- 9 ED2227 Series details and dimensions
- 10 ED2227 Product specifications
- 11 ED2227 functions

ED22/ED2227 Series Double Packs

- 12 ED22/ED2227 Series details and dimensions
- 13 ED22/ED2227 functions

Accessories - ED22/ED2227 Series Panic Exit Devices

- 14-15 Accessories and Parts, External Trims, Rods

ED22M Series

- 16 ED22 Series details and functions
- 17 ED22 Product specifications



Our panic exit devices have been designed to provide single action, push type emergency egress from buildings such as entertainment centres, hospitals, shopping centres and commercial complexes. We offer fire rated models across all panic exit device categories and our exit devices are suitable for use on doors constructed of either timber or metal.

Finishes

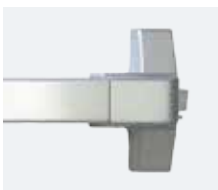

SSS Satin Stainless Steel

- > ED22 Series
- > ED2227 Series
- > ED22M Series



SIL Silver

- > ED22 Series
- > ED2227 Series

Fire Rating



The Kaba Panic Exit Devices without the dogging (latch hold back) function have been successfully tested on fire door assemblies to comply with Australian Standard AS1905-1-2005 Part 1, Fire Resistant Door Sets. All testing is carried out by independent laboratories.

When specifying/ordering add suffix "F" to code, eg. **ED22MFSSS**. ED22 and ED2227 series will be listed as No Dogging for fire rated versions.

Note: Fire doors cannot include dogging due to fire regulations.

Handing of Door - British Standards

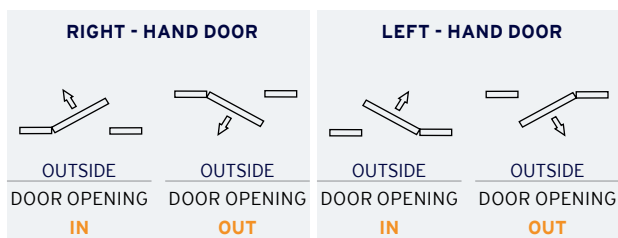

Usage Chart

Flush and Fire Doors

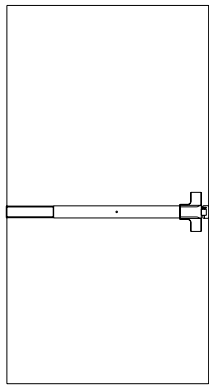

ED22/ED22M

Rebate or overlapping astragal

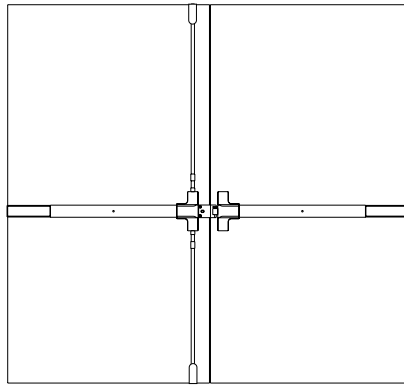

ED2227

ED22

or
ED22DP
Door co-ordinator recommended

Timber Glazed or Aluminium Doors

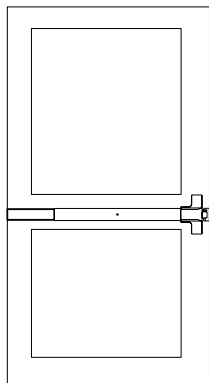

ED22/ED22M

Rebate or overlapping astragal

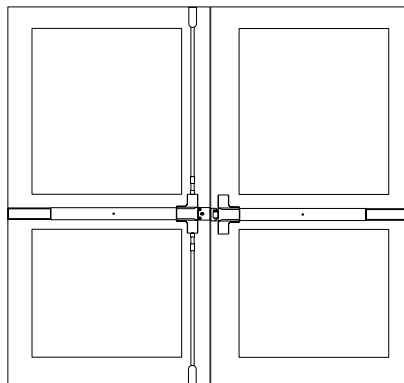

ED2227

ED22

or
Timber glazed doors - surface mounted
ED22DP
Aluminium doors - edge mounted
ED22DP plus EDP1942B strike
refer accessories and parts

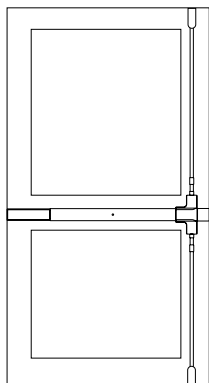

ED2227

Flush meeting

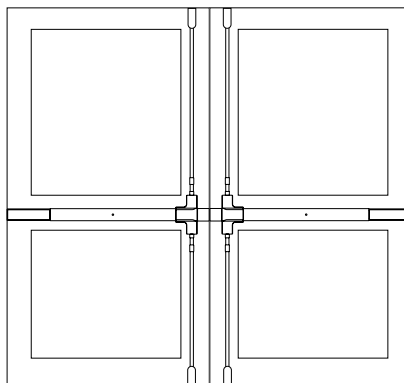

ED2227

ED22

Note: On both timber and glazed aluminium doors 105mm minimum stile plus rebate or bead stop required. Mid rail required for doors over 1050mm between door stops or when using external trims.

Dimensions

ED22 Series - Rim type

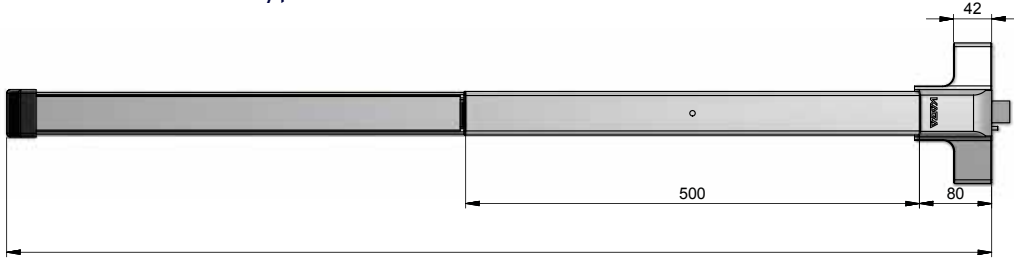

Overall length is 1085mm and can be cut down to 645mm
(685mm including cylinder dogging)

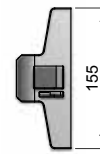

ED22M Series - Mortice type

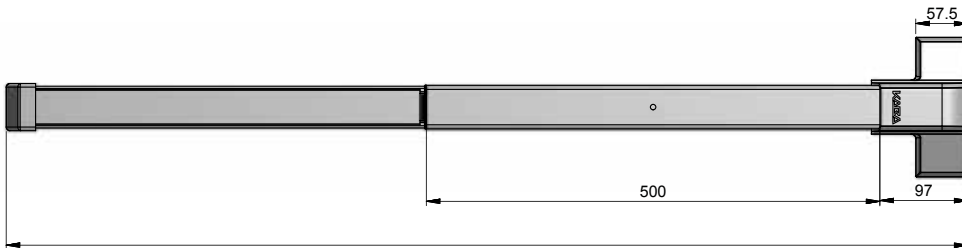

Overall length is 1060mm and can be cut down to 645mm
(685mm including cylinder dogging)

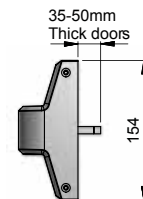

Dimensions

ED2227 Series - Vertical rod type

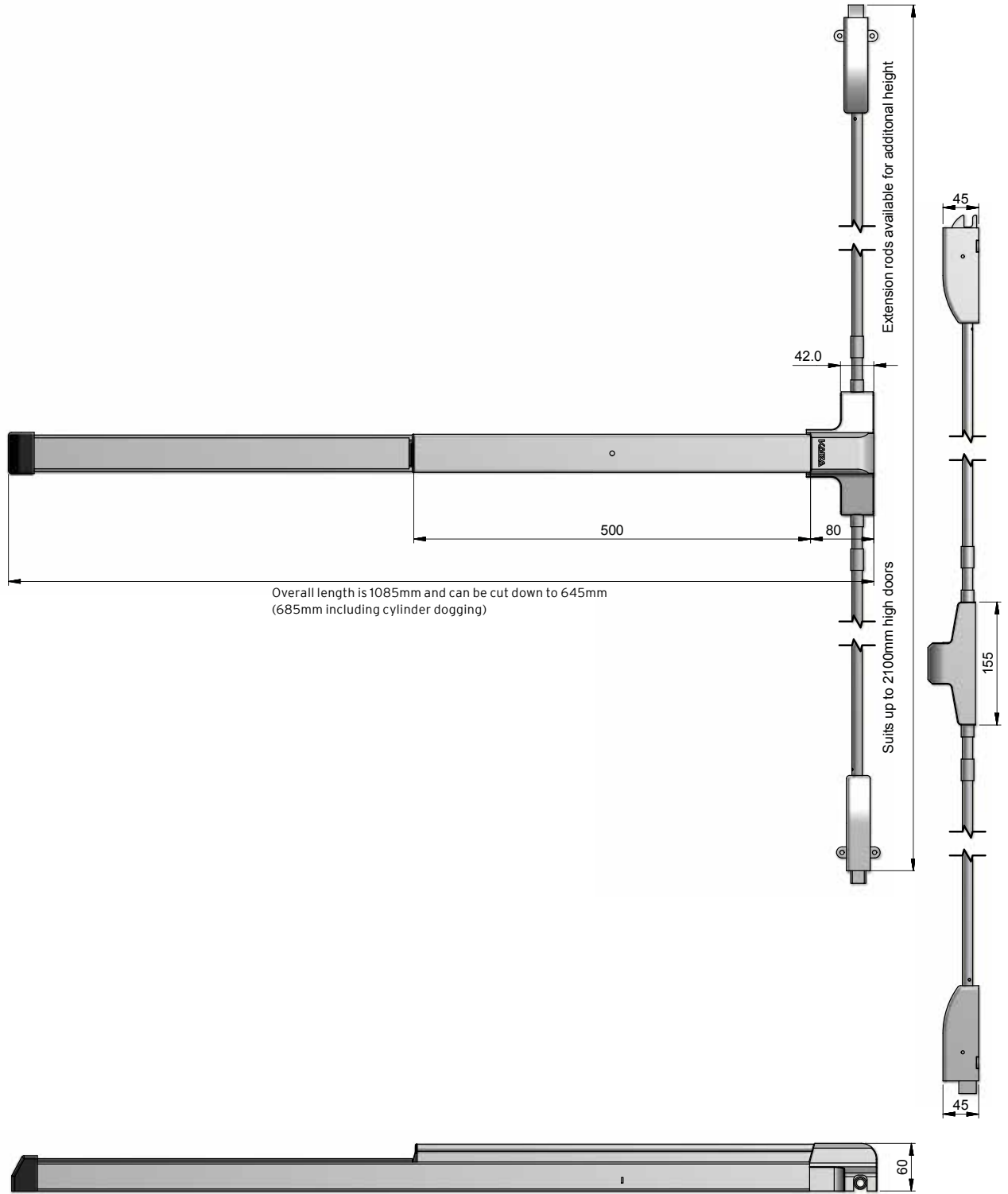



ED22 Series - Rim

The Kaba ED22 Series Rim type panic exit device is designed to provide emergency egress by a single action pushing motion via a modern design touch pad, fitted horizontally across the door. The ED22 provides secure dead latching function and offers latch hold back (dogging) options, external trim options for lever/knob or pull handle and is suitable for double or single, metal or timber doors.

ED22 Series

Exit Device

Length

Supplied in 1085mm standard length. Can be field sized to 645mm minimum length (including strike). Cylinder dogging (CD) adds 40mm to minimum length.

Stile

105mm minimum stile plus rebate or bead stop. A mid rail is required for glazed aluminium/timber doors over 1050mm between door stops or when using external trims.

Fixings

Timber self-tapping screws and metal machines screws supplied as standard.

Construction

Pressed and cast metal casing. Operating parts made of steel and brass. Main and auxiliary latch bolt constructed of stainless steel

Handing

Non handed

Finish

Silver (painted) and Satin Stainless Steel (SSS)

Dogging

Hex (Allen) key type supplied as standard. Optional cylinder dogging available - when specifying/ordering use suffix "CD" (Factory fitted).

Note: Fire doors cannot include dogging due to fire regulations.

Fire Rating

The Kaba ED22 has been successfully tested on fire door assemblies in accordance with Australian Standard AS 1905 Part 1: Fire resistant door sets. When specifying/ordering add suffix "F" to code, eg. ED22E0FSIL.

Note: Fire doors cannot include dogging due to fire regulations.

External trim

121 Cylinder for Nightlatch (NL) function or Key in knob/Key in lever for classroom function. Through fixing Pull handle on plate available as pull only or D pull with round hole to suit rim cylinder.

Note: DP pull with round hole is handed - available as accessories.



OPTIONAL EXTERNAL TRIMS

				
FUNCTION	CYLINDER	NOB	LEVER	PULL HANDLE
NIGHTLATCH	121			
CLASSROOM		EDK70	EDL70	
NO FUNCTION				ED22PH
NIGHTLATCH				ED22PHNL

ED22 Series - Functions

Rim Devices

SUFFIX	INSIDE ACTION	OUTSIDE ACTION
EO	Exit only	Nil
NL	Exit only	Key entry

For Square Edge Stile Aluminium Doors only - order ED1942B in addition to the exit device.
For external trims and accessories refer to the Exit Device Accessories and Parts page.

HEX KEY DOGGING - RIM DEVICES

CODE	FINISH	DESCRIPTION
ED22EOSIL	SIL	ED22 - Exit Only - 1085mm SIL Contents: ED22, PS01-95SSS
ED22EOSSS	SSS	ED22 - Exit Only - 1085mm SSS Contents: ED22, PS01-95SSS
ED22NLSIL	SIL	ED22 - Night Latch - 1085mm SIL Contents: ED22, 121 Cylinder, PS01-95SSS
ED22NLSSS	SSS	ED22 - Night Latch - 1085mm SSS Contents: ED22, 121 Cylinder, PS01-95SSS

NO DOGGING - RIM DEVICES



PRODUCT CODE	FINISH	DESCRIPTION
ED22EOFIL	SIL	ED22 - Exit Only, Fire rated - 1085mm SIL Contents: ED22, PS01-95SSS
ED22EOFSSS	SSS	ED22 - Exit Only, Fire rated - 1085mm SSS Contents: ED22, PS01-95SSS
ED22NLFIL	SIL	ED22 - Night Latch, Fire rated - 1085mm SIL Contents: ED22, 121 Cylinder, PS01-95SSS
ED22NLFSSS	SSS	ED22 - Night Latch, Fire rated - 1085mm SSS Contents: ED22, 121 Cylinder, PS01-95SSS

CYLINDER DOGGING - RIM DEVICES

PRODUCT CODE	FINISH	DESCRIPTION
ED22EOCDSIL	SIL	ED22 - Exit Only - 1085mm SIL Contents: ED22, 140 Cylinder, PS01-95SSS
ED22EOCDSSS	SSS	ED22 - Exit Only - 1085mm SSS Contents: ED22, 140 Cylinder, PS01-95SSS
ED22NLCDSIL	SIL	ED22 - Night Latch - 1085mm SIL Contents: ED22, 121 Cylinder, 140 Cylinder, PS01-95SSS
ED22NLCDSSS	SSS	ED22 - Night Latch - 1085mm SSS Contents: ED22, 121 Cylinder, 140 Cylinder, PS01-95SSS



ED2227 Series - Vertical Rod

The Kaba ED2227 Series vertical rod type panic exit device is designed to provide emergency egress by a single action pushing motion via a modern design touch pad, fitted horizontally across the door. The ED2227 provides secure two point latching in top and bottom of door and offers latch hold back (dogging) options, external trim options for lever/knob and is suitable for double or single, metal or timber doors.

ED2227 Series

Exit Device

Length

Supplied in 1085mm standard length. Can be field sized to 645mm minimum length (including strike). Cylinder dogging (CD) adds 40mm to minimum length.

Height

Suits 2100mm high doors. Extension rods available in 600mm lengths.

Stile

105mm minimum stile plus rebate or bead stop. A mid rail is required for glazed aluminium/timber doors over 1050mm between door stops or when using external trims.

Fixings

Timber self tapping screws and metal machine screws supplied as standard.

Construction

Pressed and cast metal casing. Operating parts made of steel and brass. Stainless steel Latchbolts

Handing

Reversible

Finish

Silver (painted) & Satin Stainless Steel (SSS)

Dogging

Hex (Allen) key type supplied as standard. Optional cylinder dogging available - when specifying/ordering use suffix "CD" (Factory fitted).

Fire Rating

The Kaba ED2227 has been successfully tested on fire door assemblies in accordance with Australian Standard AS 1905 Part 1: Fire resistant door sets.

When specifying/ordering add suffix "F" to code, eg. ED22E0FSIL.

Note: Fire doors cannot include dogging due to fire regulations.



External trim

121 Cylinder for Nightlatch (NL) function or Key in knob/Key in lever for classroom function. Through fixing Pull handle on plate available as pull only or D pull with round hole to suit rim cylinder

Note: DP pull with round hole is handed - available as accessories.

OPTIONAL EXTERNAL TRIMS

			
FUNCTION	CYLINDER	NOB	LEVER
NIGHTLATCH	121		
CLASSROOM		EDK70	EDL70

ED22 Series - Functions

Rim Devices

SUFFIX	INSIDE ACTION	OUTSIDE ACTION
EO	Exit only	Nil
NL	Exit only	Key entry

For Square Edge Stile Aluminium Doors only - order ED1942B in addition to the exit device.
For external trims and accessories refer to the Exit Device Accessories and Parts page.

HEX KEY DOGGING - VERTICAL ROD DEVICES

CODE	FINISH	DESCRIPTION
ED2227EOSIL	SIL	ED2227 - Exit Only - 1085mm SIL Contents: ED2227, PS04-95SSS, PS11, PS1609-95SSS
ED2227EOSSS	SSS	ED2227 - Exit Only - 1085mm SSS Contents: ED2227, PS04-95SSS, PS11, PS1609-95SSS
ED2227NLSIL	SIL	ED2227 - Night Latch - 1085mm SIL Contents: ED2227, 121 Cylinder, PS04-95SSS, PS11, PS1609-95SSS
ED2227NLSSS	SSS	ED2227 - Night Latch - 1085mm SSS Contents: ED2227, 121 Cylinder, PS04-95SSS, PS11, PS1609-95SSS

NO DOGGING - VERTICAL ROD DEVICES



CODE	FINISH	DESCRIPTION
ED2227E0FSIL	SIL	ED2227 - Exit Only, Fire rated - 1085mm SIL Contents: ED2227, PS04-95SSS, PS11, PS1609-95SSS
ED2227E0FSSS	SSS	ED2227 - Exit Only, Fire rated - 1085mm SSS Contents: ED2227, PS04-95SSS, PS11, PS1609-95SSS
ED2227NLFSIL	SIL	ED2227 - Night Latch, Fire rated - 1085mm SIL Contents: ED2227, 121 Cylinder, PS04-95SSS, PS11, PS1609-95SSS
ED2227NLFSSS	SSS	ED2227 - Night Latch, Fire rated - 1085mm SSS Contents: ED2227, 121 Cylinder, PS04-95SSS, PS11, PS1609-95SSS

CYLINDER DOGGING - VERTICAL ROD DEVICES

CODE	FINISH	DESCRIPTION
ED2227EOCDSIL	SIL	ED2227 - Exit Only - 1085mm SIL Contents: ED2227, 140 Cylinder, PS04-95SSS, PS11, PS1609-95SSS
ED2227EOCDSSS	SSS	ED2227 - Exit Only - 1085mm SSS Contents: ED2227, 140 Cylinder, PS04-95SSS, PS11, PS1609-95SSS
ED2227NLCDSIL	SIL	ED2227 - Night Latch - 1085mm SIL Contents: ED2227, 121 Cylinder, 140 Cylinder, PS04-95SSS, PS11, PS1609-95SSS
ED2227NLCDSSS	SSS	ED2227 - Night Latch - 1085mm SSS Contents: ED2227, 121 Cylinder, 140 Cylinder, PS04-95SSS, PS11, PS1609-95SSS



ED22/ED2227 Series Double Packs

The Kaba ED22DP series double pack panic exit devices are designed to provide emergency egress by a single action pushing motion via a modern design touch pad, fitted horizontally across the doors. The ED22DP provides secure locking in double door applications and offers latch hold back (dogging) options, external trim options for lever/knob and is suitable for double or single, metal or timber doors.

ED22/ED2227 Series - Functions

Double Packs

SUFFIX	INSIDE ACTION	OUTSIDE ACTION
EO	Exit only	Nil
NL	Exit only	Key entry

For Square Edge Stile Aluminium Doors only - order ED1942B in addition to the exit device.
For external trims and accessories refer to the Exit Device Accessories and Parts page.

HEX KEY DOGGING - DOUBLE PACKS

CODE	FINISH	DESCRIPTION
ED22DPEOSIL	SIL	Double Pack - Exit Only - 1085mm SIL Contents: ED22, ED2227, EDP01-05SSS, PS1609-95SSS
ED22DPEOSSS	SSS	Double Pack - Exit Only - 1085mm SSS Contents: ED22, ED2227, EDP01-05SSS, PS1609-95SSS
ED22DPNLSIL	SIL	Double Pack - Night Latch - 1085mm SIL Contents: ED22, ED2227, 121 Cylinder, EDP01-05SSS, PS1609-95SSS
ED22DPNLSSS	SSS	Double Pack - Night Latch - 1085mm SSS Contents: ED22, ED2227, 121 Cylinder, EDP01-05SSS, PS1609-95SSS

NO DOGGING - DOUBLE PACKS



PRODUCT CODE	FINISH	DESCRIPTION
ED22DPEOFSIL	SIL	Double Pack - Exit Only, Fire rated - 1085mm SIL Contents: ED22, ED2227, EDP01-05SSS, PS1609-95SSS
ED22DPEOFSSS	SSS	Double Pack - Exit Only, Fire rated - 1085mm SSS Contents: ED22, ED2227, EDP01-05SSS, PS1609-95SSS
ED22DPNLF SIL	SIL	Double Pack - Night Latch, Fire rated - 1085mm SIL Contents: ED22, ED2227, 121 Cylinder, EDP01-05SSS, PS1609-95SSS
ED22DPNLFSSS	SSS	Double Pack - Night Latch, Fire rated - 1085mm SSS Contents: ED22, ED2227, 121 Cylinder, EDP01-05SSS, PS1609-95SSS

CYLINDER DOGGING - DOUBLE PACKS

PRODUCT CODE	FINISH	DESCRIPTION
ED22DPEOCSIL	SIL	Double Pack - Exit Only - 1085mm SIL Contents: ED22, ED2227, 140 Cylinder, EDP01-05SSS, PS1609-95SSS
ED22DPEOCSSS	SSS	Double Pack - Exit Only - 1085mm SSS Contents: ED22, ED2227, 140 Cylinder, EDP01-05SSS, PS1609-95SSS
ED22DPNLCSIL	SIL	Double Pack - Night Latch - 1085mm SIL Contents: ED22, ED2227, 121 Cylinder, 140 Cylinder, EDP01-05SSS, PS1609-95SSS
ED22DPNLCSSS	SSS	Double Pack - Night Latch - 1085mm SSS Contents: ED22, ED2227, 121 Cylinder, 140 Cylinder, EDP01-05SSS, PS1609-95SSS

ED22/ED2227 Series Panic Exit Devices

Accessories and Parts

EDP01-05SSS

ED22 Standard strike and shim



EDP04-95SSS

ED2227 Top vertical rod strike



EDP1942B

ED22 Edge mounted strike



EDP1609-95

ED22DP Standard surface mount strike and shim



EDP11

ED2227 Brass floor socket



CODE	FINISH	DESCRIPTION
EDP01-05SSS	SSS	ED22 Standard strike and shim
EDP04-95SSS	SSS	ED2227 Top vertical rod strike
EDP1942B	SSS	ED22 Edge mounted strike
EDP1609-95	SSS	Standard surface mount strike & shim
EDP901		ED Vertical Rod Latch Cover
EDP902		ED Vertical Rod Guide - Steel
EDP904		ED Vertical Rod Connecting Pin
EDP905		ED End Cap and Bracket - Nylon
EDP907		ED Vertical Rod - Top - 890mm
EDP908		ED Vertical Rod - Bottom - 840mm
EDP920		ED Latch Mechanism and Cover - Top
EDP921		ED Latch Mechanism and Cover - Bottom
EDP922		ED Dogging Key (Allen)
EDP925		ED Guide Sleeve to suit EDP902 - Nylon
EDP926		ED Slide Cover
EDP11		ED2227 Brass floor socket

ED22/ED2227 Series Panic Exit Devices

External Trims

EDK70SSS

Knob



CODE	FINISH	DESCRIPTION
EDK70SSS	SSS	Knob - Classroom Function

EDL70SCP

Lever



CODE	FINISH	DESCRIPTION
EDL70SCP	SCP	Lever - Classroom Function

ED22PH

Pull Handle and Plate

suitable for ED22 Rim device only

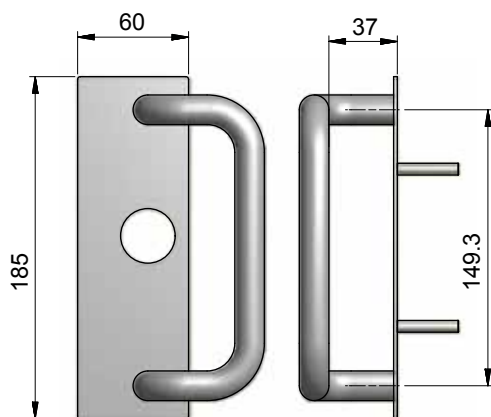

CODE	FINISH	DESCRIPTION
ED22PHSSS	SSS	ED22 Pull Handle and Plate

ED22PHNL

Pull Handle and Plate - Night Latch

suitable for ED22 Rim device only

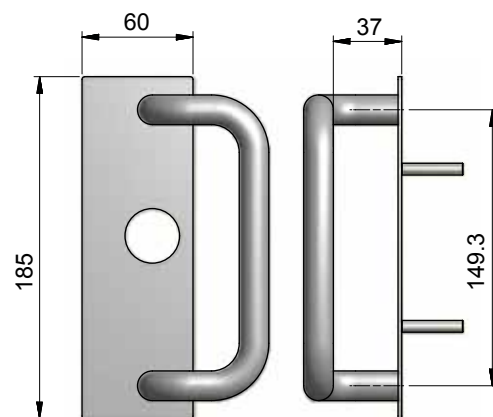

CODE	FINISH	DESCRIPTION
ED22PHNLSSSL	SSS	ED22 Pull Handle and Plate - LH
ED22PHNLSSSR	SSS	ED22 Pull Handle and Plate - RH

Extension Rod

CODE	FINISH	DESCRIPTION
ED22/44ERSSS	SSS	ED Extension Rod - 600mm for doors over 2100mm SSS
ED22/44ERSIL	SIL	ED Extension Rod - 600mm for doors over 2100mm SIL
ED22/44EROSSS	SSS	ED Extension Rod - 1700mm one-piece SSS
ED22/44EROSIL	SIL	ED Extension Rod - 1700mm one-piece SIL



ED22M - Exit Device

The Kaba ED22M has been designed to operate in conjunction with the renowned Kaba MS2 mortice lock.

The ED22M offers all the security functions of the MS2 mortice lock whilst providing a fast and convenient means of escape in the case of an emergency. The exit device is supplied with convenient mounting plates, providing fast, secure and easy thru fixing to timber doors.

PRODUCT CODE	FINISH	DESCRIPTION
ED22MSSS	SSS	ED22M - Exit Only Mortice Lock - 1060mm SSS
ED22MFSSS	SSS	ED22M - Exit Only Mortice Lock, Fire rated - 1060mm SSS

ED22M Exit Device

Mortice Lock Panic Exit Device

The ED22M is supplied complete with ED22 exit device and MS2ED (modified for double doors) mortice lock.

Length

Supplied in 1060mm standard length. Can be field sized to 645mm minimum length.

Mounting

- > Timber - Mounting plates and thru fixing screws (supplied).
- > Metal/Aluminium - Fixing direct to metal surface less mount plates (fixings not included). Drill and tap recommended.

Stile

115mm to suit metal/aluminium where mounting plates are not used. A mid rail is required if mounting plates are fitted or if the door opening is greater than 1050mm.

Door Thickness

35mm up to 50mm thick door as standard. Thicker doors on application.

Fixings

Supplied as standard with fixings for surface & thru fixing (surface fixings supplied as self-tapping timber screws).

Dogging

Hex (Allen) key type supplied as standard. Cylinder dogging by external hold back cylinder.

Note: Fire doors cannot include dogging due to fire regulations.

Handing

Reversible

Finish

Satin Stainless Steel (SSS)

Fire Rating

A fire rated version of the ED22M (ED22MF) is available.

This version comes without the dogging function.

The ED22MF has been successfully tested on fire door assemblies in accordance with Australian Standard AS1905 Part 1: Fire door sets.

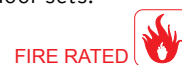

When specifying/ordering add suffix "F" to code, eg. ED22MFSSS.

Note: Fire doors cannot include dogging due to fire regulations.

OPTIONAL EXTERNAL TRIMS

	600 SERIES	100 SERIES	WAFE	TAFE	LEVER HANDLES	CLEVER
NIGHTLATCH	604	104	-	-	FA270/FA280	
STOREROOM	601F	101F	WAFE03	TAFE03	240F/270F/ 280F/740F + FA270/FA280	Refer to c-lever options for all functions
CLASSROOM	601	101	-	-	240/270/ 280/740 +FA270/FA280	

Panic Exit Devices

Notes
