

WN 056748-45632
08/09

- RZ-TMS 24V
- + TL-S DCW®
- + TV XXX DCW®
- + SVP-S DCW® (Option)

RZ-TMS 24V

TL-S TMS 2

SVP-S 2x DCW® (Option)

Netzteil / Power supply
nach DIN EN 60950
24V DC +15% / -5%
1,5 A

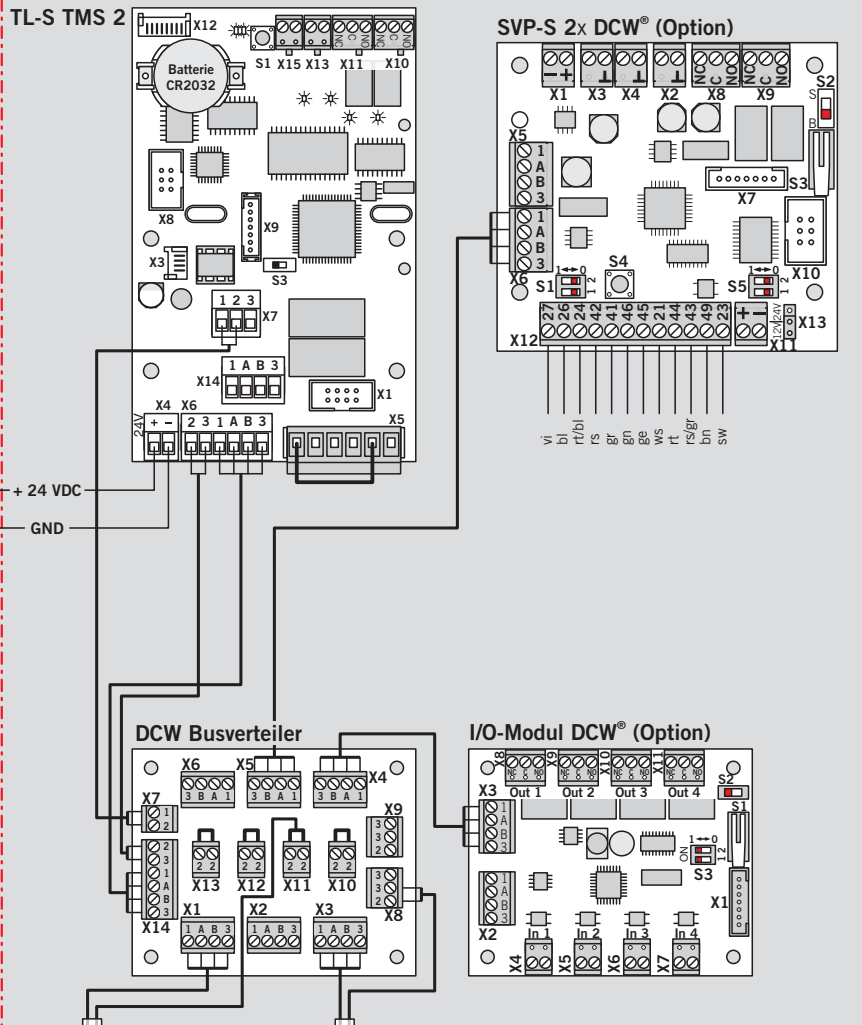

TL-S DCW®

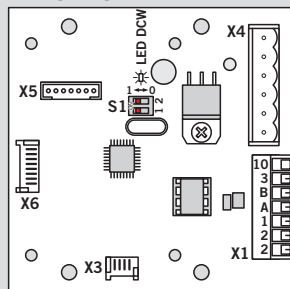

TV 50x

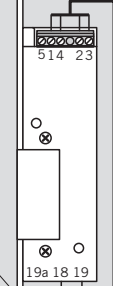

I - Y (ST) Y 4 x 2 x 0,8
Kabel geschützt verlegen

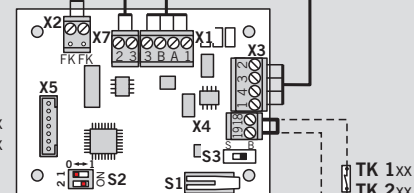
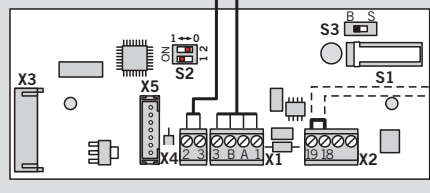
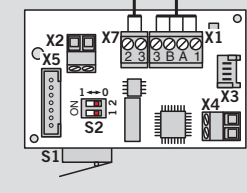

1 TV 1xx DCW® -- und/oder -- TV 2xx DCW® -- und/oder -- TV 50x DCW®

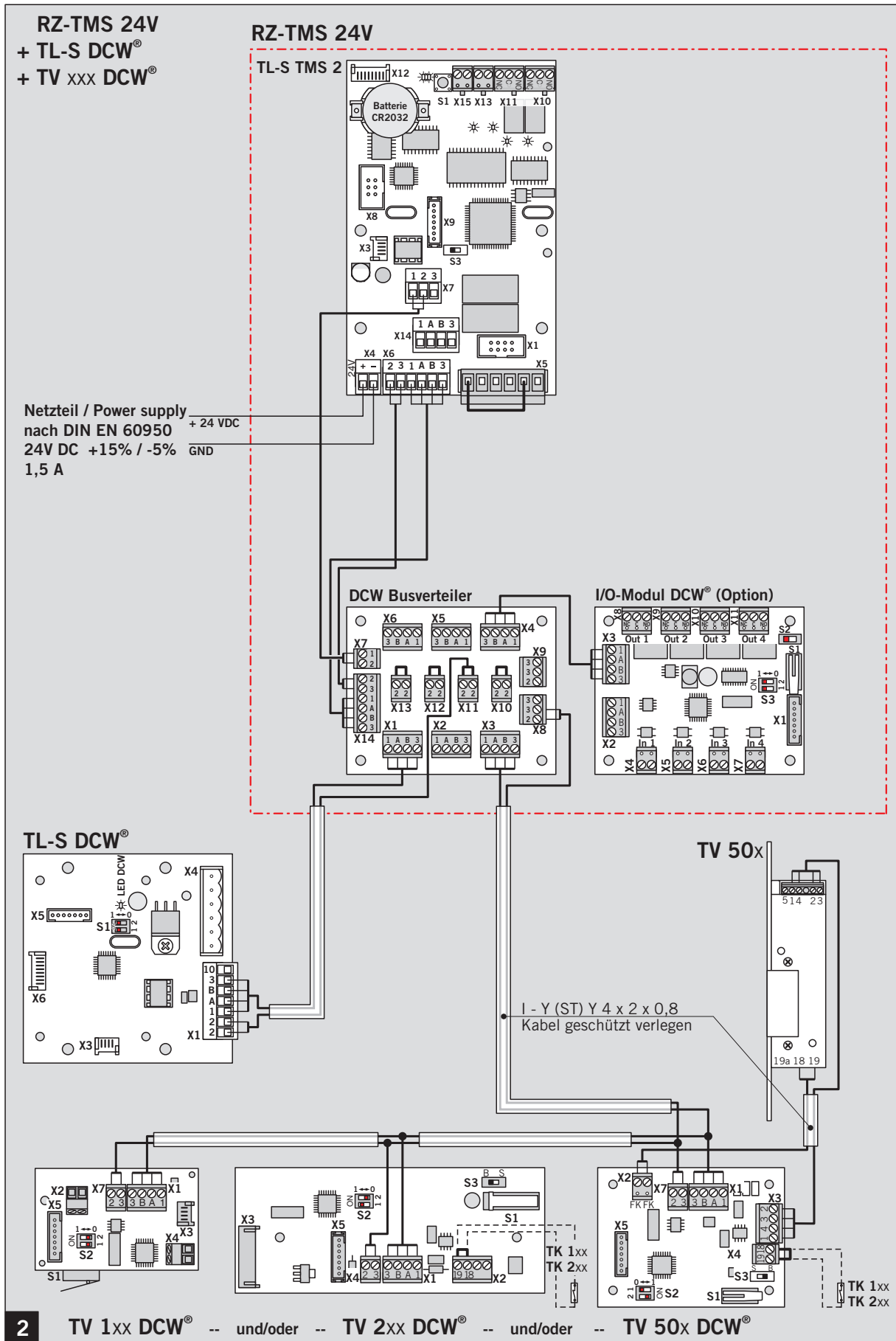

RZ-TMS 24V
 + 2x TL-S DCW®
 + TV 1xx DCW®

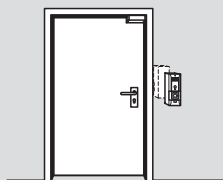

Parameter setup

128 100 #
 127 101 #

Sonderfunktionen

Externe Geräte

- Notschalter ist angeschlossen (an Klemme X7)
- Rauchmelder ist angeschlossen (an Klemme X7)
- Rauchmelder ist angeschlossen (an TMS-IO4)

TMS-Soft

Netzteil / Power supply
 nach DIN EN 60950
 24V DC +15% / -5%
 1,5 A

RZ-TMS 24V

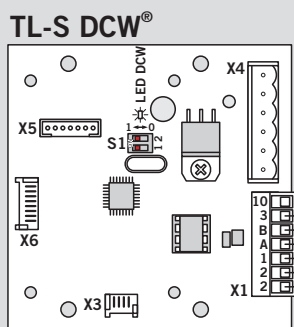
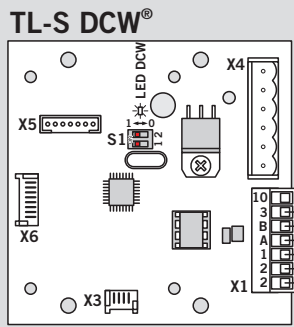
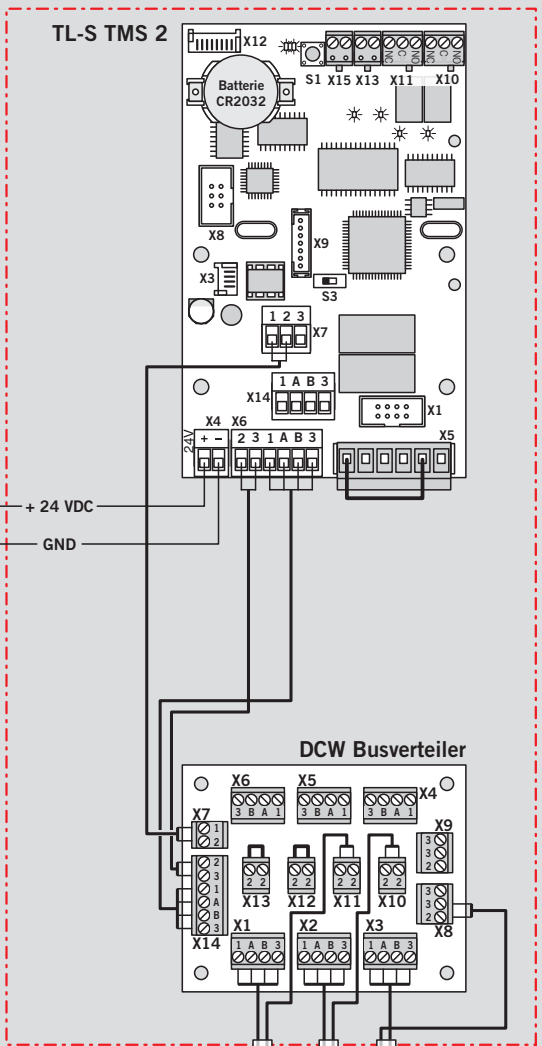

I - Y (ST) Y 4 x 2 x 0,8
 Kabel geschützt verlegen

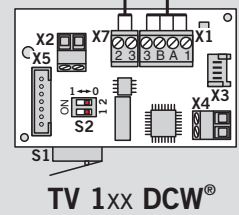

Anderungen vorbehalten
Subject to change without notice