

WN 057662 45532  
09/08

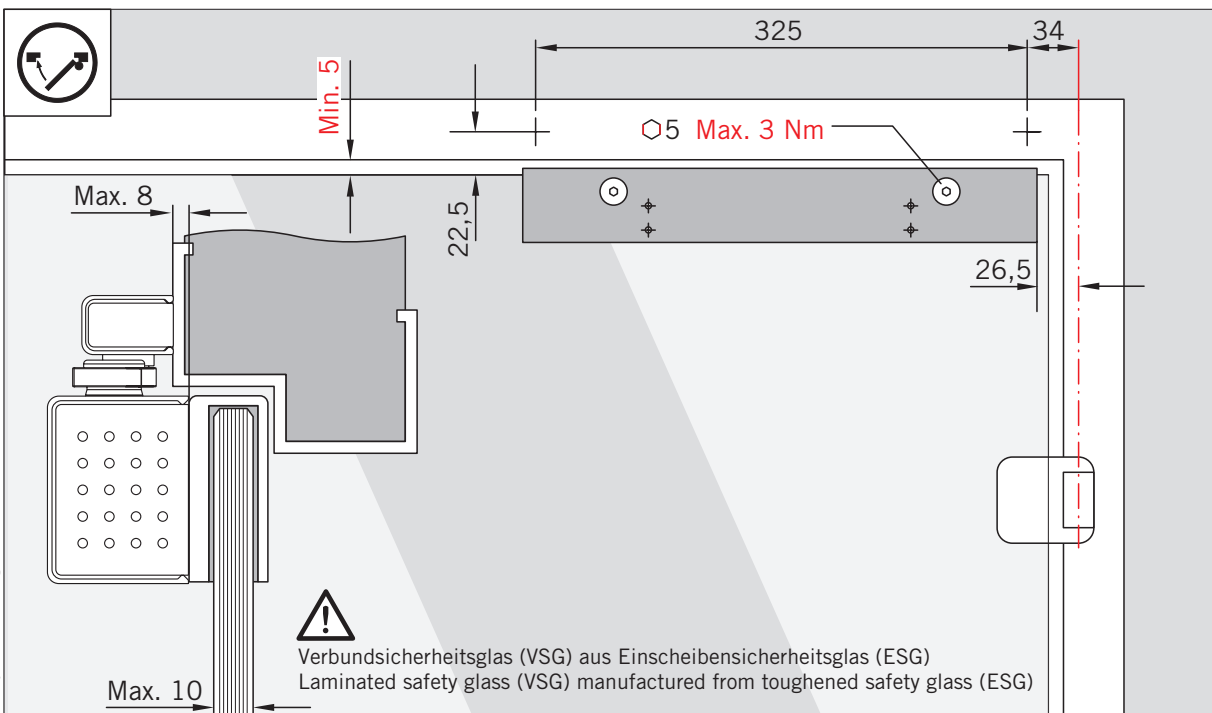
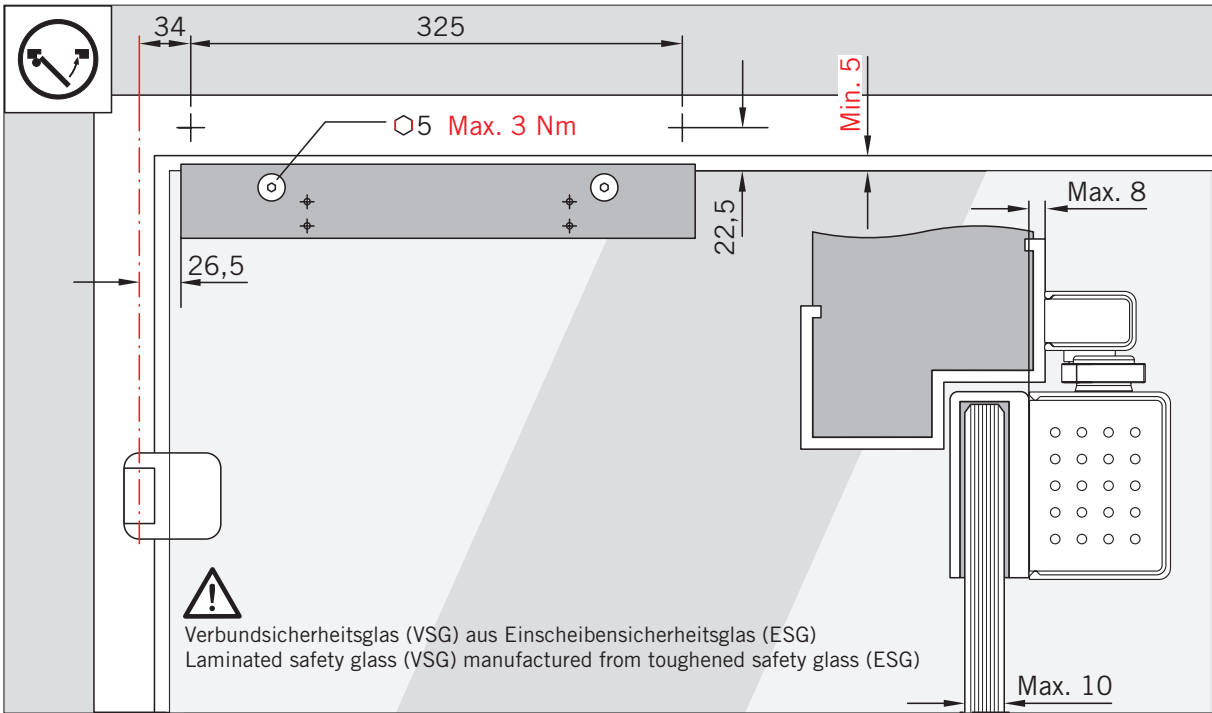
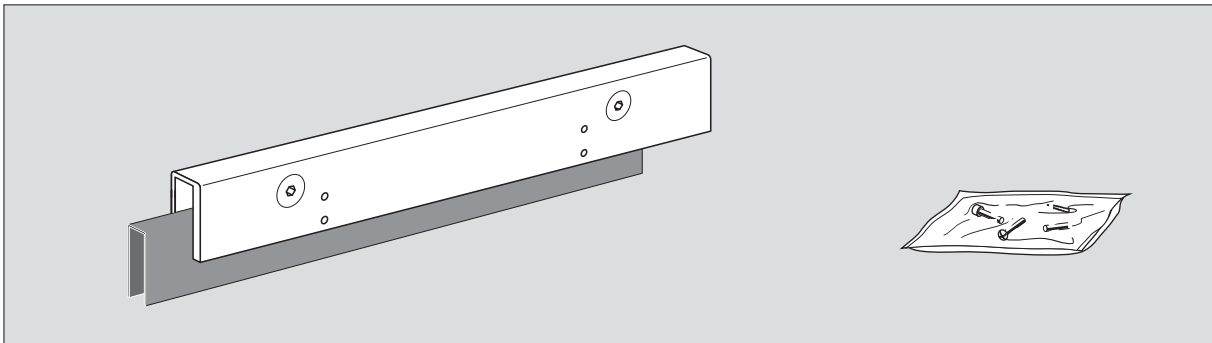

Änderungen vorbehalten  
Subject to change without notice