

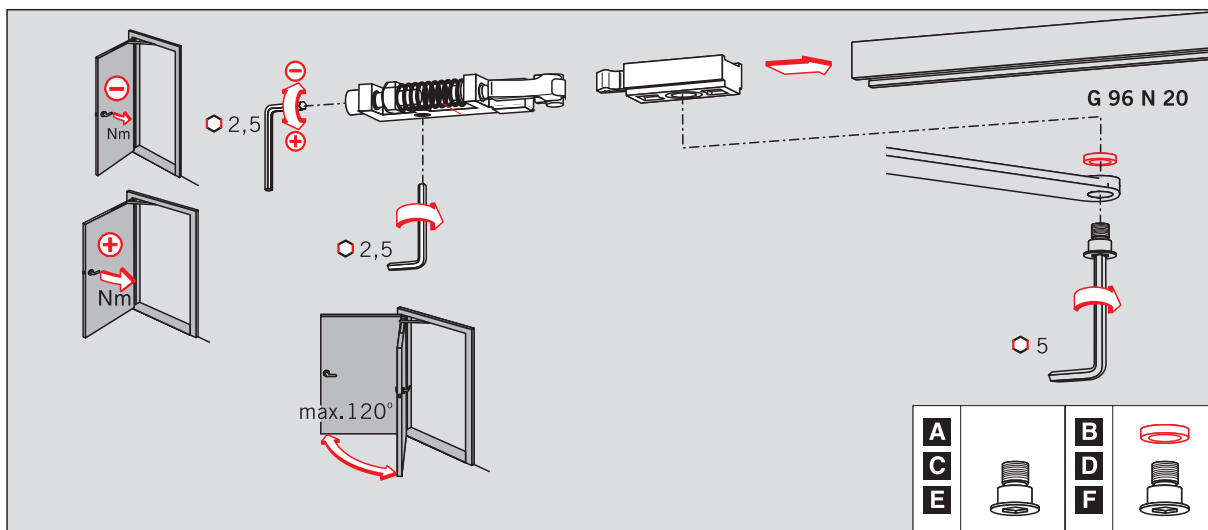

WN 055994 45532
01/09

Art. Nr.52005600

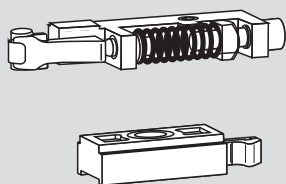
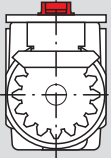
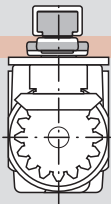
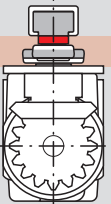
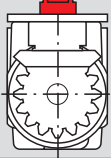
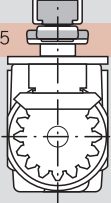
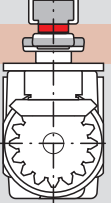
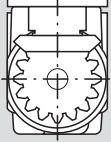
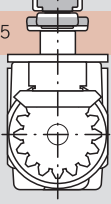
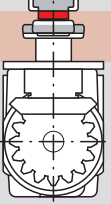

	G 96 N20 K8/K12	
	DIN L 52 00 37 01	DIN R 52 00 38 01
	K8	K12
ITS 96 EN 2-4 52 40 01 50 EN 3-6 52 25 01 50 	 X=8,5 A	 X=12 B
ITS 96 EN 2-4 52 41 01 50 EN 3-6 52 26 01 50 	 X=12,5 C	 X=16 D
ITS 96 EN 2-4 52 42 01 50 EN 3-6 52 27 01 50 	 X=16,5 E	 X=20 F

Änderungen vorbehalten
 Subject to change without notice