

1 Laufschiene
mit 300er
Bohrungsabstand
Z.-Nr. 8.15.241.001.40
Art.-Nr. 15.597

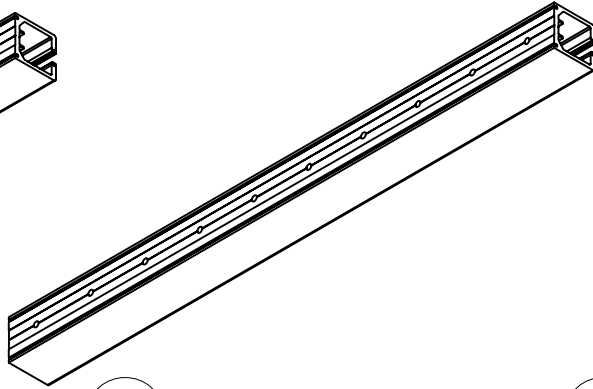

2 Laufschiene
mit 100er
Bohrungsabstand
Z.-Nr. 8.15.241.002.40
Art.-Nr. 15.593

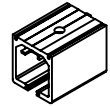

3 Revisionsstück
Z.-Nr. 8.15.241.010.40
Art.-Nr. 15.618

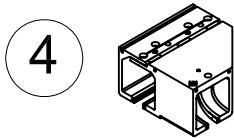

4 90°-Abzweig
Links
Z.-Nr. 8.15.402.001.55
Art.-Nr. 15.624

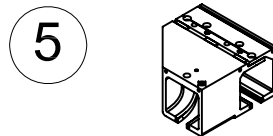

5 90°-Abzweig
Rechts
Z.-Nr. 8.15.403.001.55
Art.-Nr. 15.625

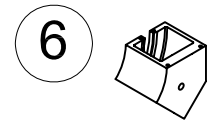

6 45°-Bogen
Aussen eckig
Z.-Nr. 8.15.411.002.40
Art.-Nr. 15.629

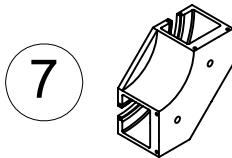

7 90°-Bogen
Innen-Aussen eckig
Z.-Nr. 8.15.408.001.40
Art.-Nr. 15.626

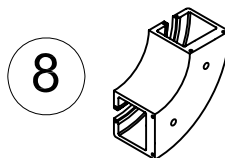

8 90°-Bogen
Innen-Aussen rund
Z.-Nr. 8.15.410.001.40
für Abzweige 91°-149°
Art.-Nr. 15.628

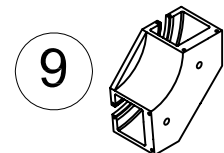

9 85°-Bogen
Z.-Nr. 8.15.409.002.40
Art.-Nr. 15.627

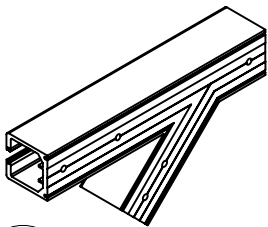

10 135°-Bahnhofseinlauf
Links
Z.-Nr. 8.15.241.003.50
Art.-Nr. 15.570

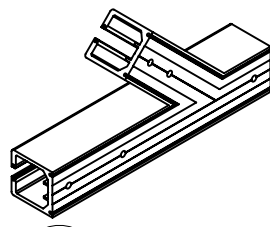

11 135°-Bahnhofseinlauf
Rechts
Z.-Nr. 8.15.241.004.50
Art.-Nr. 15.571

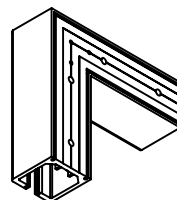

12 L-Stück
Z.-Nr. 8.15.241.005.50
Art.-Nr. 15.574

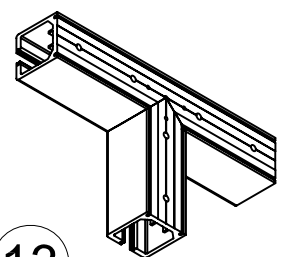

13 T-Stück
Z.-Nr. 8.15.241.007.50
Art.-Nr. 15.573