

PORTEO. Quick-Start Manual.



I. Installation on the push and pull side



- Define which **electrical connections** are required:
 - Plug & Go (plug mains connector into mains outlet) or
 - Direct mains connection (cable from the wall)



⚠ Work must be carried out by a qualified electrician!

2. Installation

- Transom fixing (standard)**
See installation drawings **A B C D**
- Door leaf** fixing
See installation drawings **E F G H**
⚠ Cable loop required!



3. Once installed, commission PORTEO as follows.

II. Standard commissioning procedure

⚠ For transom-fixed units with slide channel on the pull side, on doors up to 60 kg in leaf weight and up to 1000 mm in width. If these limits are exceeded, perform the advanced commissioning procedure – see Operating Manual.



- Connect mains supply.
- Switch mains disconnecter to "OFF".
- Set programme switch to "0".

4. Determining the direction of door opening:

- Open door approx. 5°.
- At the same time, press and hold** the Service pushbutton and switch the mains disconnecter to "ON"; maintain these settings until door moves (approx. 8 sec.).
- Release Service pushbutton (green LED flashes).
- Door moves to "Door Closed" position (direction of door swing has now been stored).

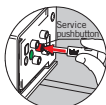

5. Determining the "Door Opened" position:

- Move door to required Open position (max. 110°) (green LED flashes).
- Press the Service pushbutton once and then release (green LED glows for 3 sec., then flashes).
⚠ Start of the learning (teach-in) cycle (do not interrupt this).
- Door moves to "Door Closed" position ("Door Opened" position has now been stored). The PORTEO is now ready to operate.

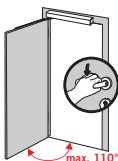

6. Advance settings.

Changing the settings of the potentiometers (see Item V).

III. Programme switch



Switch position 0 = OFF

- The electrical functions of the PORTEO are switched off.
- The door can be operated using a lever handle or a key.



Switch position I = Operating modes.

- The electrical functions of the PORTEO are switched on.



Switch position II = Permanent Open

- PORTEO holds the door open for as long as is required.

Permanent Open function also available as an option in conjunction with a pushbutton activator: Briefly press the pushbutton twice (current impulse relay function). Or programmable with handheld transmitter.

IV. Operating modes



1. "PowerLess" mode

- Effortless manual opening of door with lever handle.
- For doors with standard lock and lever handle.



Setting the "PowerLess" mode:

- Switch mains disconnecter to "ON".
- Set programme switch to "I".
- Rotate **potentiometer 1** (Speed) fully counter-clockwise to the "PowerLess" position.



2. "Push&Go" mode

- Manual opening of door – from 3° PORTEO cuts in to open the door automatically.
- For doors with standard lock and lever handle.

Setting the "Push&Go" mode:

- Switch mains disconnecter to "ON".
- Set programme switch to "I".
- "Push&Go" automatically cuts in from a door opening angle of 3°.



⚠ Potentiometer 1 (Speed) needs to be turned anywhere away from the "PowerLess" position.



3. "PowerMotion" mode

Automatic door opening and closing. For doors with a standard lock, **electric strike** and **external activators** (optional accessories).

Setting the "PowerMotion" mode:

- Switch mains disconnecter to "ON".
- Set programme switch to "I".



⚠ Potentiometer 1 (Speed) needs to be turned anywhere away from the "PowerLess" position.

For more information on the **PowerMotion mode** and requisite accessories, see back page!

V. Potentiometer (controller) and DIP switch settings

⚠ Potentiometers should be adjusted using the special tool only.



Adjusting the opening and closing times (Speed)

5 – 10 sec.

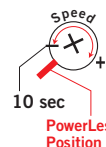

- Switch mains disconnecter to "ON".
- Using **potentiometer 1** adjust the opening and closing time (Speed) (infinitely adjustable, factoring setting 10 sec. operating time).
 - = Lowest speed (10 sec. operating time)
 - + = Highest speed (5 sec. operating time)

⚠ Make sure that you do not confuse the positions "PowerLess" and lowest speed (just before the "PowerLess" position).

Adjusting the hold-open time

Hold-open time = Time between end of opening operation and start of closing operation

5 – 30 sec.



- Switch mains disconnecter to "ON".
- Using **Potentiometer 2**, adjust the hold-open time as required:
 - = 5 sec. hold-open time
 - + = 30 sec. hold-open time

0,5 – 30 sec.

- in the "PowerLess" mode:
- = 0.5 sec. hold-open time
 - + = 30 sec. hold-open time

Settings in combination with an electric strike (option)

Once commissioning has been completed, set **DIP switch A** to activate the electric strike.

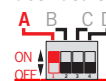

Set **DIP switch A** to "ON".

This activates the "electric strike" function.

0,2 – 3 sec.



Adjusting the unlocking time

Unlocking time = Time that elapses between the activation signal and start of the door opening cycle. Using **Potentiometer 4**, adjust the unlocking time as required:

- = 0.2 sec. unlocking time
- + = 3 sec. unlocking time

⚠ During the unlocking time, the door is slightly pulled into the frame so that the latch does not jam or stick. So make sure the unlocking time is not too short!

Activating/De-activating the latching action:

Latching action = Acceleration of the closing speed over the last few degrees of the closing sweep to ensure latch engagement.

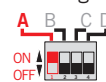

DIP switch A to "ON":

Latching action and electric strike activated

DIP switch A to "OFF":

Latching action and electric strike de-activated

PORTEO. Accessories.

In the **PowerMotion** mode (automatic door opening, automatic door closing), an electric strike is needed in order to release the door latch. A signal is emitted by an external activator, the door opens on release of the latch by the electric strike, and then automatically closes after a preset hold-open time.



DORMA Basic electric strike



Electric strike with adjustable latch, suitable for over-rebated and flush-closing doors, non-handed. 24 V DC, 130 mA

Models:

- Basic: Fail-secure (locked when power disconnected), Art. No. 15117124
- Basic-Safe: Fail-safe (unlocked when power disconnected), Art. No. 15137124

Accessories: Stainless steel striking plate type FLM 24, Art. No. 15180224

Once the PORTEO has been commissioned, set **DIP switch A** to on to activate the electric strike. For other settings, see front page.

DORMA System 55 handheld pushbutton



Function 1 – Open Door

Press pushbutton:

- Door opens and closes

Function 2 – Permanent Open

1. Quickly double-click pushbutton (current impulse relay function):
 - Door opens and remains in that position.
2. Quickly double-click pushbutton again:
 - Door closes.

Art. No.:
19144701170

DORMA BRC-R radio receiver

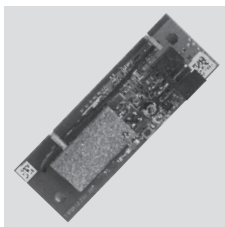

Technical data

Frequency: 433.92 MHz
Output: 1 channel, floating N.O. contact, self-learning for up to 64 transmitters
Power supply data: 24 V DC
Current input: max. 100 mA

Art. No.: 29302002

The DORMA BRC-R radio receiver (required for the DORMA atent transmitter) is installed in the PORTEO unit. When using the DORMA atent transmitter, therefore, there is none of the cabling that otherwise has to be installed for door activation.

Installation of the BRC-R radio receiver

1. Connect the wires from the PORTEO to the PCB as indicated by the colour code.

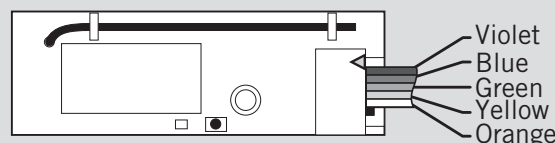

2. Once the handheld transmitter has been programmed/married to the receiver, wrap the PCB in sponge rubber and slide into the compartment.

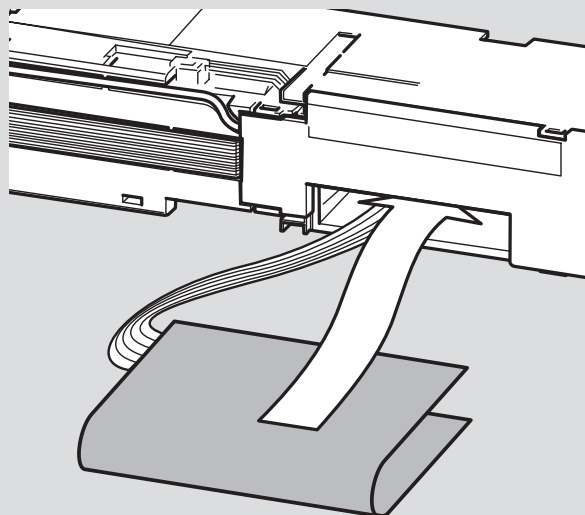

DORMA atent transmitter



Technical data

Frequency: 433.92 MHz,
4 channels, digitally coded, with individual assignability
Power supply: 12 V battery
Range: 15 m indoors

Art. No.: 60041500

The DORMA atent enables doors to be opened and closed by radio remote control. Several transmitters can be married to each receiver. **Each transmitter must be programmed/married individually.**

Functional description

Function 1 – Open Door

Press the programmed pushbutton on the transmitter:

- The door moves to the Opened position and closes after the preset hold-open time.

Function 2 – Permanent Open

Press the programmed pushbutton on the transmitter:

- The door moves to the Opened position and remains there. Press the same pushbutton again: Door closes.

Programming

Function 1 – Open Door

1. Briefly depress the SW pushbutton on the BRC-R receiver PCB.
 - The LED on the pushbutton glows for 5 sec.
2. During these 5 sec., press one of the pushbuttons on the transmitter.
 - Function 1 is programmed and is available at this pushbutton.

Function 2 – Permanent Open

1. Depress the SW pushbutton on the BRC-R receiver PCB until the LED next to the pushbutton extinguishes again.
 - The LED flashes 30 times.
2. This is followed by a brief steady glow (approx. 3 sec.). As soon as you see this steady glow, press a pushbutton on the transmitter.

Cancelling the programmed settings

The programming must be cancelled before the pushbuttons are re-assigned with different functions.

1. Switch off the BRC-R receiver (switch mains disconnecter to "OFF").
2. Press and hold pushbutton SW on the BRC-R receiver PCB.
3. Switch on power again (mains disconnecter "ON").
 - LED lights up
4. Release pushbutton SW immediately.

Terminal diagram: Electric strike and activator

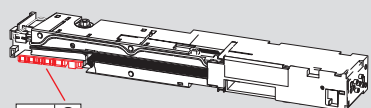

- 1U 64 Jumper 1U to 64 = Basic electric strike (fail-secure)
- 63 Jumper 1U to 63 = Basic-Safe electric strike (fail-safe)

