

- NOTES:
- FOR DIMENSIONS AND TOLERANCES REFER TO CORRESPONDING DOOR PREPARATION DRAWING IP#.
 - FOR EXIT DEVICE AND MORTISE LOCK CUT-OUT REFER TO EXIT DEVICE MANUFACTURER INSTALLATION INSTRUCTIONS.
 - BACKSET SHOWN FOR REFERENCE ONLY, ADJUST BACKSET TO EXIT DEVICE MANUFACTURER INSTALLATION INSTRUCTIONS.
 - HOLES A: FROM THE INSIDE OF THE DOOR, DRILL HOLES (SEE TABLE)
 - SYMBOLS:
 - ∇ DEEP
 - \ominus CENTER LINE OF DOOR
 - \varnothing DIAMETER
 - \rightarrow NOT TO SCALE
 - HOLES D: ONLY LOCK WITH MESSENGER OR BLUETOOTH. FOR COMPLETE HOLE PATTERN REFER TO DRAWING IP-515149/DT-515149 (RIM OR MORTISE LOCKS).
 - ALL DIMS INCHES [mm]

HOLE ID	DIM INCH/(mm)	∇ INCH/(mm)	COMMENTS
A	$\varnothing 5/16$ (7,95)	$\nabla 3/4$ (19,05)	SEE NOTE #4
B	$\varnothing 1/2$ (12,7)	*	-
C	$\varnothing 1$ (25,4)	*	SEE NOTE #2
D	$\varnothing 3/4$ (19,05)	*	SEE NOTE #6

* UNLESS OTHERWISE NOTED, DRILL HALF DOOR THICKNESS ON BOTH SIDES.

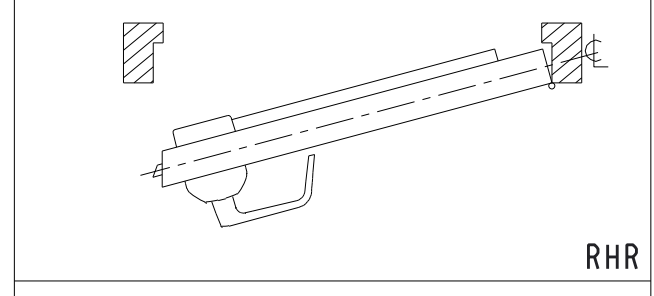
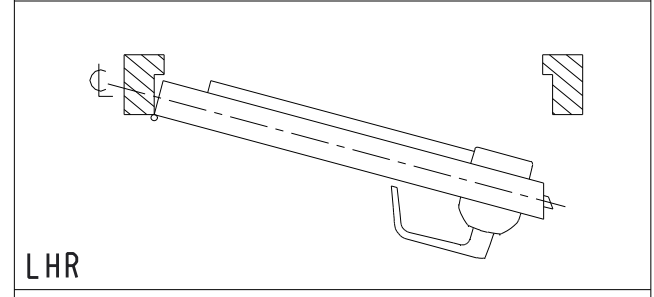

DO NOT REPRODUCE
CONTACT CUSTOMER SUPPORT
ILCO 1-877-468-3555
SAFLOK 1-800-999-6213
E-PLEX POWER-PLEX
1-800-849-8324

630, 730, 750, 79E, E-PLEX 2000 AND POWER-PLEX 2000 LOCK SERIES DRILLING TEMPLATE ARROW S3888



www.kabalodgingsupport.com

SHEET 1 OF 2	DATE 11NO2016	UNE VERSION FRANCAISE DE CE DOCUMENT EST DISPONIBLE SUR DEMANDE.	
	ECN 16007	DT-513127	REV-3

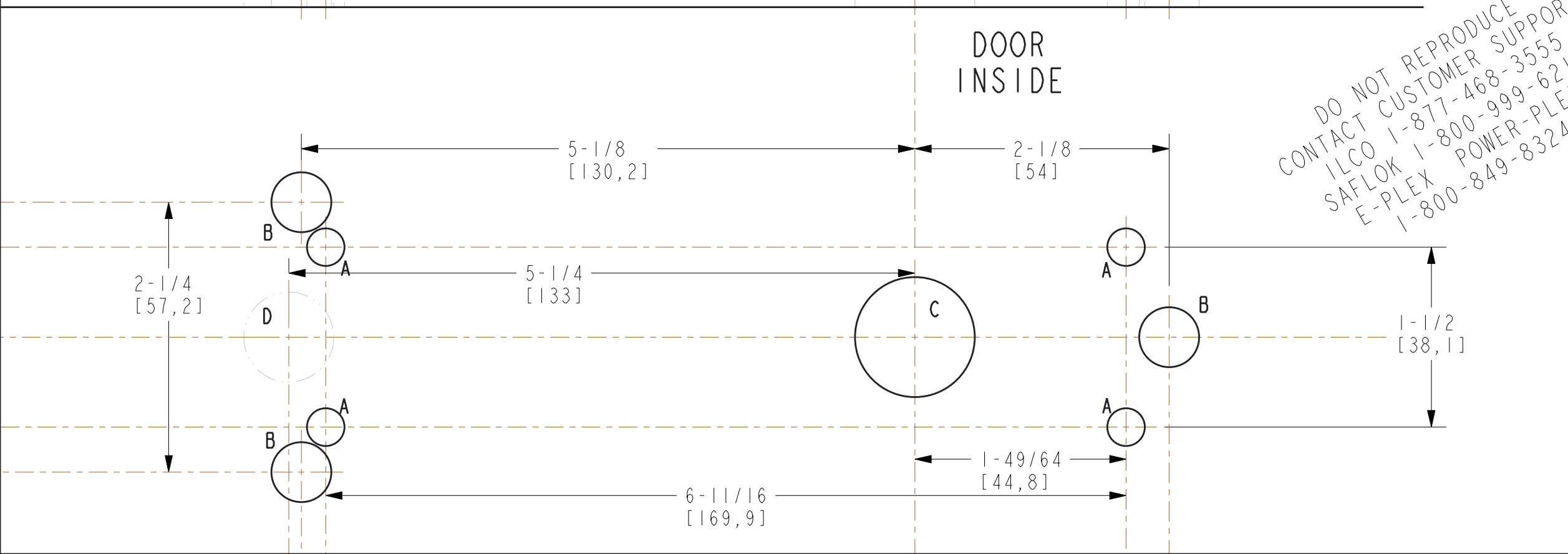
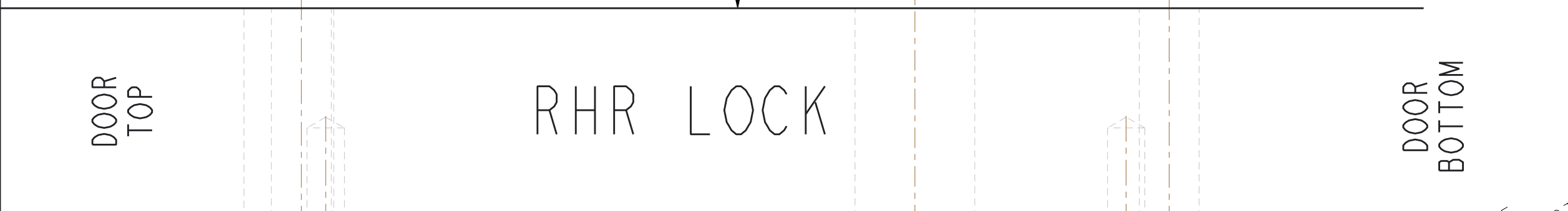
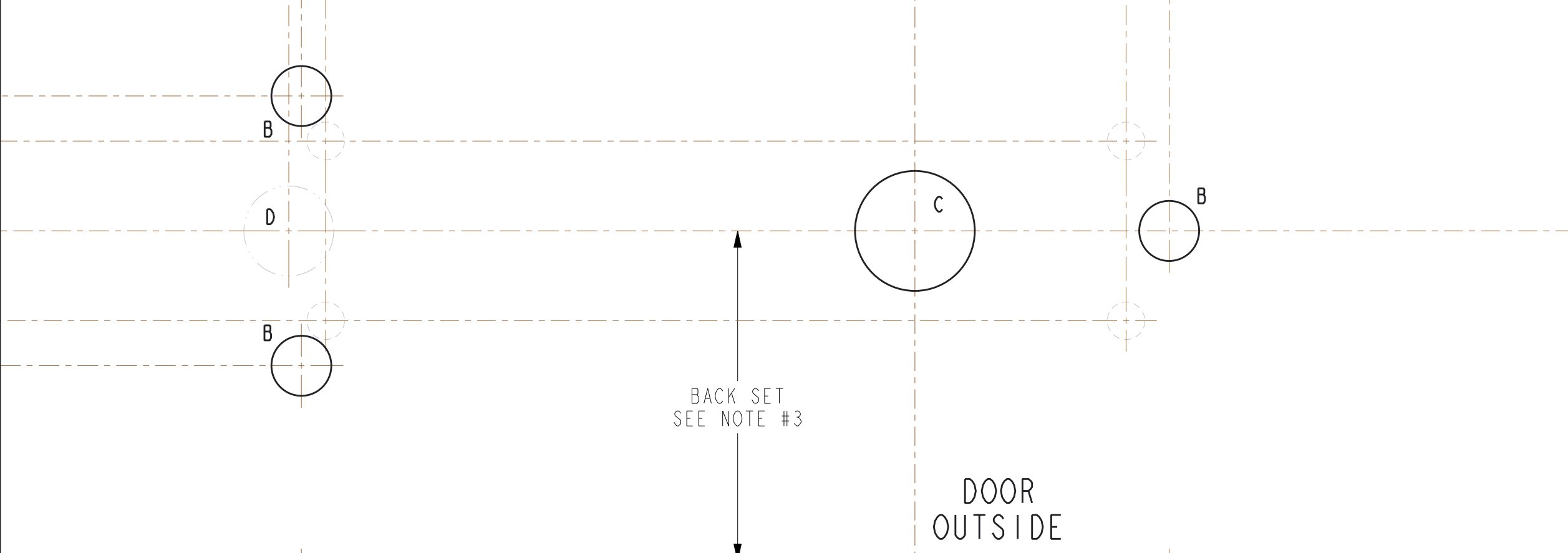

DO NOT REPRODUCE
 CONTACT CUSTOMER SUPPORT
 ILCO 1-877-468-3555
 SAFLOK 1-800-999-6213
 E-PLEX POWER-PLEX
 1-800-849-8324

- NOTES:
- FOR DIMENSIONS AND TOLERANCES REFER TO CORRESPONDING DOOR PREPARATION DRAWING IP#.
 - FOR EXIT DEVICE AND MORTISE LOCK CUT-OUT REFER TO EXIT DEVICE MANUFACTURER INSTALLATION INSTRUCTIONS.
 - BACKSET SHOWN FOR REFERENCE ONLY, ADJUST BACKSET TO EXIT DEVICE MANUFACTURER INSTALLATION INSTRUCTIONS.
 - HOLES A: FROM THE INSIDE OF THE DOOR, DRILL HOLES (SEE TABLE)
 - SYMBOLS:
 - ∇ DEEP
 - \odot CENTER LINE OF DOOR
 - \emptyset DIAMETER
 - \rightarrow NOT TO SCALE
 - HOLES D: ONLY LOCK WITH MESSENGER OR BLUETOOTH. FOR COMPLETE HOLE PATTERN REFER TO DRAWING IP-515149/DT-515149 (RIM OR MORTISE LOCKS).
 - ALL DIMS INCHES [mm]

HOLE ID	DIM INCH/(mm)	∇ INCH/(mm)	COMMENTS
A	\emptyset 5/16 (7,95)	∇ 3/4 (19.05)	SEE NOTE #4
B	\emptyset 1/2 (12,7)	*	-
C	\emptyset 1 (25,4)	*	SEE NOTE #2
D	\emptyset 3/4 (19.05)	*	SEE NOTE #6

* UNLESS OTHERWISE NOTED, DRILL HALF DOOR THICKNESS ON BOTH SIDES.

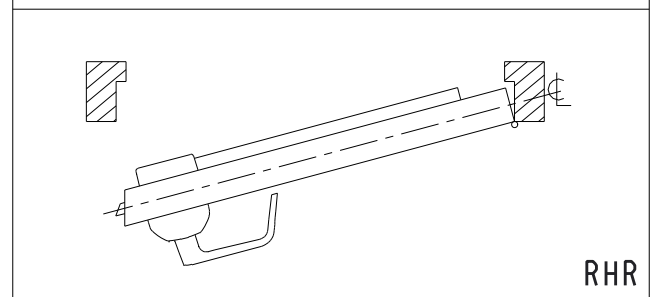
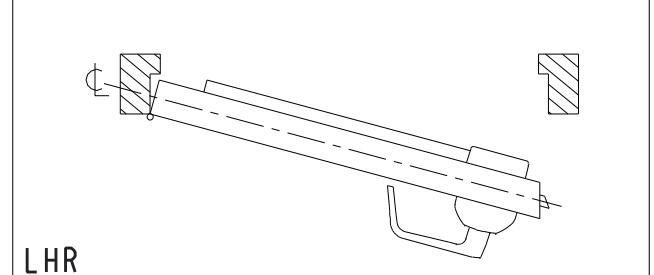

630, 730, 750, 79E, E-PLEX 2000 AND POWER-PLEX 2000 LOCK SERIES DRILLING TEMPLATE ARROW S3888



www.kabalodgingsupport.com

SHEET 2 OF 2	DATE 11NO2016	UNE VERSION FRANCAISE DE CE DOCUMENT EST DISPONIBLE SUR DEMANDE.	
	ECN 16007	DT-513127	REV-3