

- NOTES:
- 1- FOR DIMENSIONS AND TOLERANCES REFER TO CORRESPONDING DOOR PREPARATION DRAWING IP#.
  - 2- FOR EXIT DEVICE AND MORTISE LOCK CUT-OUT REFER TO EXIT DEVICE MANUFACTURER INSTALLATION INSTRUCTIONS.
  - 3- BACKSET SHOWN FOR REFERENCE ONLY, ADJUST BACKSET TO EXIT DEVICE MANUFACTURER INSTALLATION INSTRUCTIONS.
  - 4- HOLES A: FROM THE INSIDE OF THE DOOR, DRILL HOLES (SEE TABLE)
  - 5- SYMBOLS: -  $\nabla$  DEEP  
-  $\perp$  CENTER LINE OF DOOR  
-  $\varnothing$  DIAMETER  
-  $\rightarrow$  NOT TO SCALE
  - 6- HOLES D: ONLY LOCK WITH MESSENGER OR BLUETOOTH. FOR COMPLETE HOLE PATTERN REFER TO DRAWING IP-515149/DT-515149 (RIM OR MORTISE LOCKS).
  - 7- ALL DIMS INCHES [mm]

HOLE ID	DIM INCH / (mm)	$\nabla$ INCH / (mm)	COMMENTS
A	$\varnothing 5/16$ (7,95)	$\nabla 3/4$ (19.05)	SEE NOTE #4
B	$\varnothing 1/2$ (12,7)	*	-
C	$\varnothing 1$ (25,4)	*	SEE NOTE #2
D	$\varnothing 3/4$ (19.05)	*	SEE NOTE #6

\* UNLESS OTHERWISE NOTED, DRILL HALF DOOR THICKNESS ON BOTH SIDES.

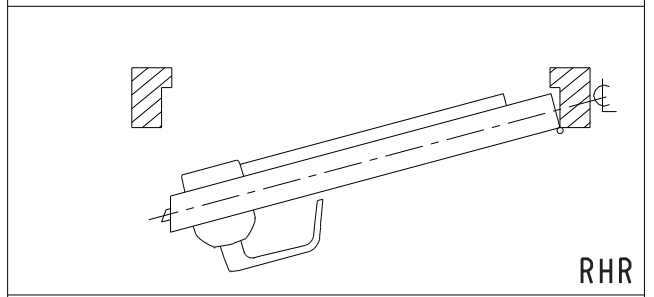
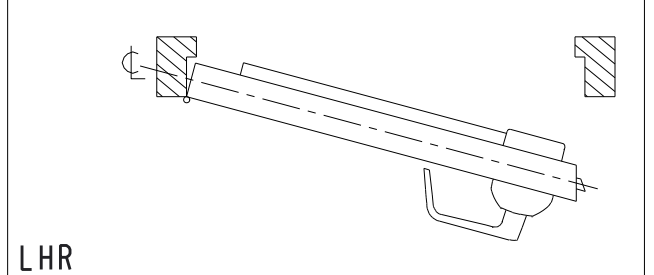

DO NOT REPRODUCE  
CONTACT CUSTOMER SUPPORT  
ILCO 1-877-468-3555  
SAFLOK 1-800-999-6213  
E-PLEX POWER-PLEX  
1-800-849-8324

630, 730, 750, 79E, E-PLEX 2000 AND POWER-PLEX 2000 LOCK SERIES DRILLING TEMPLATE VON DUPRIN 9875/9975



www.kabalodgingsupport.com

SHEET 1 OF 2	DATE 11NO2016	UNE VERSION FRANCAISE DE CE DOCUMENT EST DISPONIBLE SUR DEMANDE.
	ECN 16007	DT-513126 REV-3

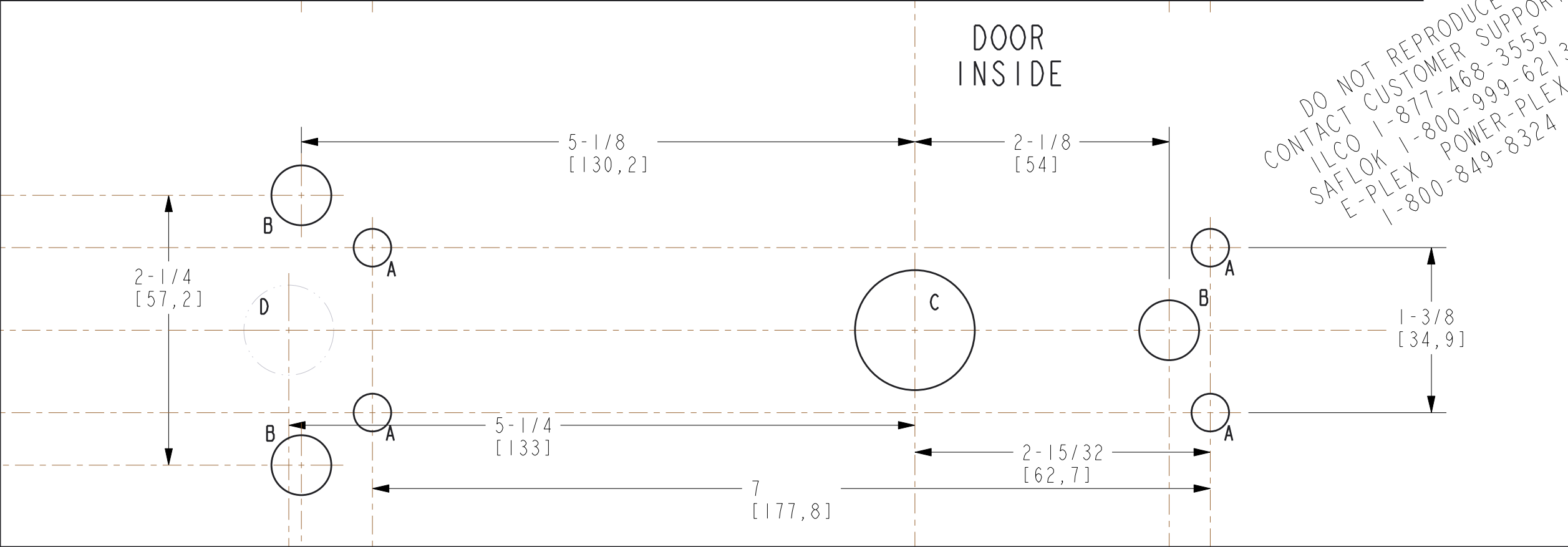
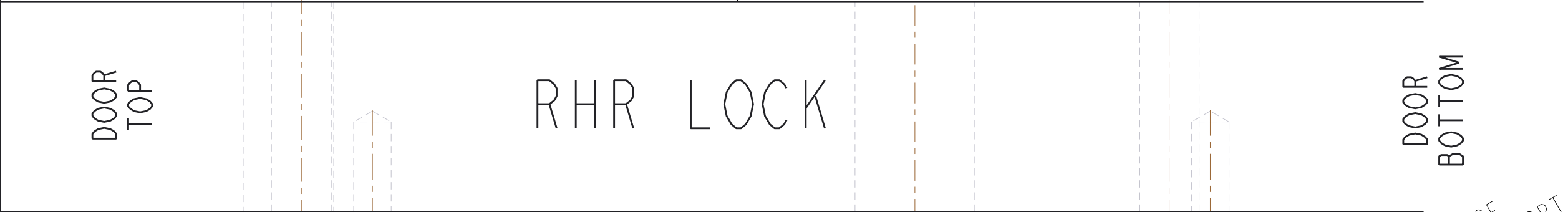
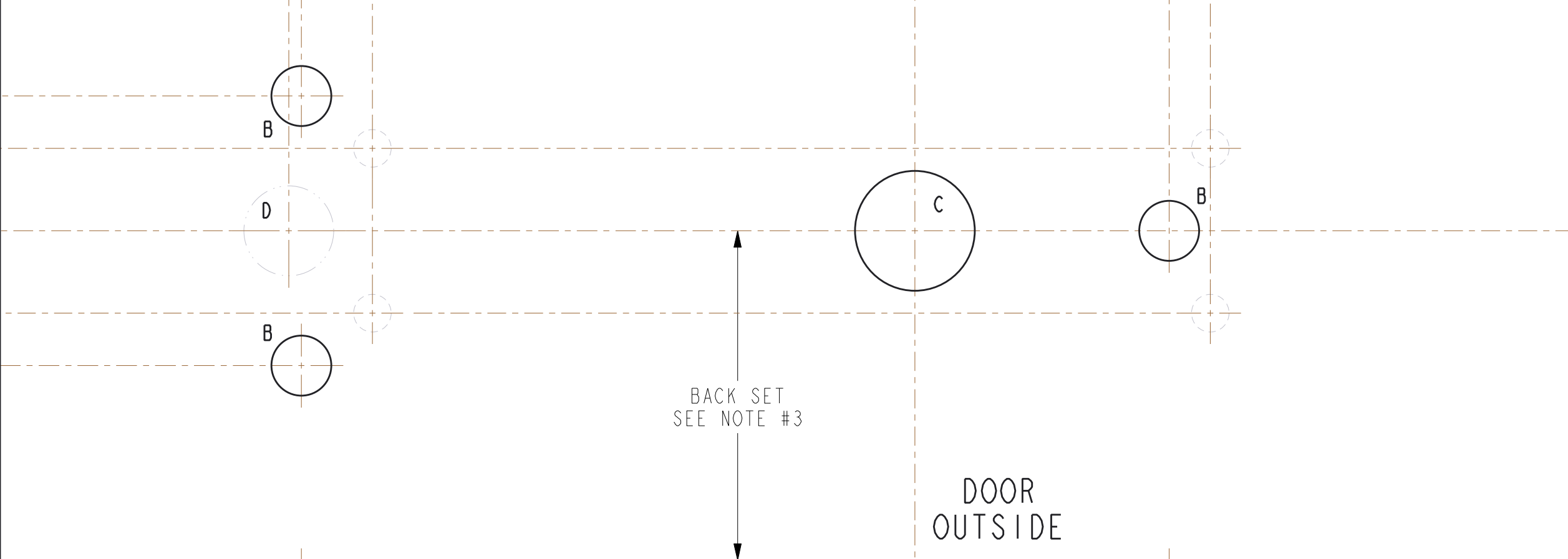

DO NOT REPRODUCE  
 CONTACT CUSTOMER SUPPORT  
 ILCO 1-877-468-3555  
 SAFLOK 1-800-999-6213  
 E-PLEX POWER-PLEX  
 1-800-849-8324

- NOTES:
- FOR DIMENSIONS AND TOLERANCES REFER TO CORRESPONDING DOOR PREPARATION DRAWING IP#.
  - FOR EXIT DEVICE AND MORTISE LOCK CUT-OUT REFER TO EXIT DEVICE MANUFACTURER INSTALLATION INSTRUCTIONS.
  - BACKSET SHOWN FOR REFERENCE ONLY, ADJUST BACKSET TO EXIT DEVICE MANUFACTURER INSTALLATION INSTRUCTIONS.
  - HOLES A: FROM THE INSIDE OF THE DOOR, DRILL HOLES (SEE TABLE)
  - SYMBOLS:
    - $\nabla$  DEEP
    - $\ominus$  CENTER LINE OF DOOR
    - $\varnothing$  DIAMETER
    - $\rightarrow$  NOT TO SCALE
  - HOLES D: ONLY LOCK WITH MESSENGER OR BLUETOOTH. FOR COMPLETE HOLE PATTERN REFER TO DRAWING IP-515149/DT-515149 (RIM OR MORTISE LOCKS).
  - ALL DIMS INCHES [mm]

HOLE ID	DIM INCH / (mm)	$\nabla$ INCH / (mm)	COMMENTS
A	$\varnothing 5/16$ (7,95)	$\nabla 3/4$ (19.05)	SEE NOTE #4
B	$\varnothing 1/2$ (12,7)	*	-
C	$\varnothing 1$ (25,4)	*	SEE NOTE #2
D	$\varnothing 3/4$ (19.05)	*	SEE NOTE #6

\* UNLESS OTHERWISE NOTED, DRILL HALF DOOR THICKNESS ON BOTH SIDES.

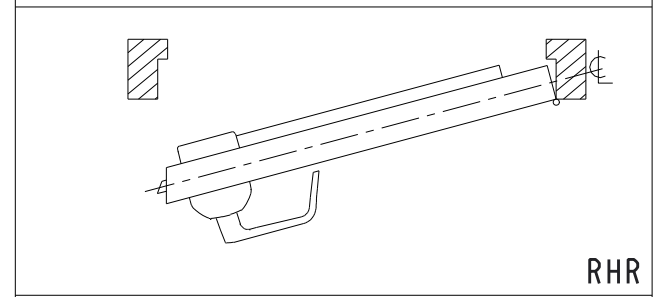
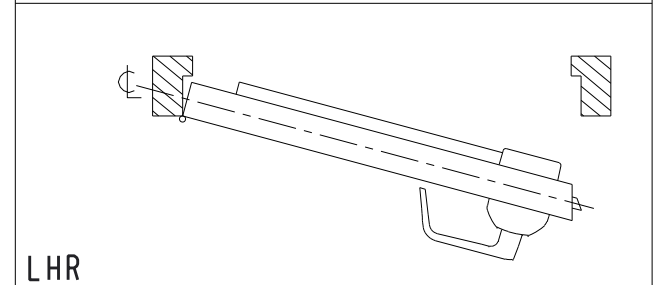

630, 730, 750, 79E, E-PLEX 2000 AND POWER-PLEX 2000 LOCK SERIES DRILLING TEMPLATE VON DUPRIN 9875/9975



www.kabalodgingsupport.com

SHEET 2 OF 2	DATE 11NO2016	UNE VERSION FRANCAISE DE CE DOCUMENT EST DISPONIBLE SUR DEMANDE.	REV-3
	ECN 16007	DT-513126	