



KABA®

SIMPLEX® FILE GUARD™ (FG SERIES)
INSTALLATION AND OPERATION INSTRUCTIONS

TABLE OF CONTENTS

Tools Required	2
Checklist	2
A. Installation	3
B. Operation	5
C. Change the Combination	5
D. Instructions for Resetting an Unknown Combination	6

Warnings and Cautions

Kaba Access Control is not responsible for damage, injury or malfunction due to incorrect installation.

Warning: For proper security, combination should be changed before lock is installed on cabinet.

Caution: Wear safety glasses when preparing file cabinet.

TOOLS REQUIRED

- $\frac{1}{8}$ " (3 mm) Drill bit
- $\frac{9}{16}$ " (14 mm) Wrench/Socket
- $\frac{13}{32}$ " (10 mm) Drill bit
- Drill (variable speed is recommended)

CHECKLIST

- Housing Assembly and Locking Bar
- Installation Manual
- Hardware Installation Pack
 - A – (2) Clevis Pins
 - B – (1) Notch Pin
 - C – (3) Lock Washers
 - D – (3) $\frac{9}{16}$ " (14 mm) Lock Nuts
 - E – (2) Mounting Screws

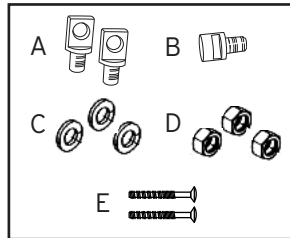

For technical assistance please call
1.800.849.TECH (8324) or 336.725.1331

A. INSTALLATION

A-1 Preassemble File Guard housing (a) to Locking Bar (b) by utilizing (2) mounting screws (c).

A-2 Position the File Guard on either side of the file cabinet.

A-3 Be sure the File Guard is parallel to the side of the file cabinet and that the top of the bar is flush or slightly lower than the top of the cabinet when marking the Notch Pin (j) location at the base of the cabinet. Make sure that the Locking Bar will engage the Notch Pin (j) sufficiently.

A-4 The bottom of the File Guard should extend enough to fully engage Notch Pin (j) and clear the floor. It may be necessary to trim the bottom of the Locking Bar to provide clearance with the floor.

A-5 Mark and drill a $\frac{1}{8}$ " pilot hole (i).

A-6 Drill a $\frac{13}{32}$ " hole (i) in the base of the file cabinet and install the Notch Pin (j).

A-7 Mount File Guard on Notch Pin (j), mark the position for Clevis Pin (h) in the upper frame of the file cabinet.

A-8 Drill a $\frac{1}{8}$ " pilot hole (g).

A-9 Drill a $\frac{13}{32}$ " hole (g) in the upper frame and install the Clevis Pin.

A-10 Optional: Install the extra Clevis Pin (f) on the side of the file cabinet to store the File Guard when not in use.

A-11 Your File Guard is now ready to use.

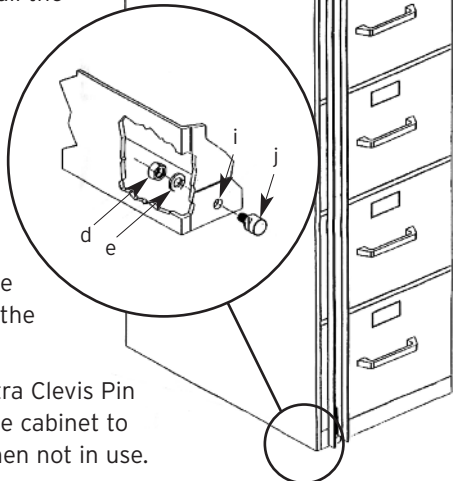
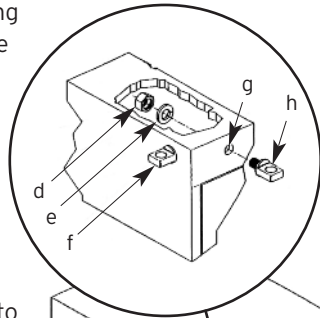
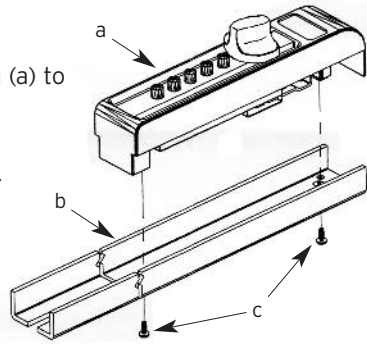

SIMPLEX® LIMITED WARRANTY

SIMPLEX® Kaba Access Control warrants the Simplex to be free from defects in material and workmanship under normal use and service for a period of one (1) year from date of purchase. Kaba Access Control will repair or replace, at our discretion, Simplex Locks found by Kaba Access Control analysis to be defective during this period. Our only liability, whether in tort or in contract, under this warranty is to repair or replace products that are returned to Kaba Access Control within the one (1) year warranty period.

This warranty is in lieu of and not in addition to any other warranty or condition, express or implied, including without limitation merchantability, fitness for purpose or absence of latent defects.

ATTENTION: This warranty does not cover problems arising out of improper installation, neglect or misuse. All warranties implied or written will be null and void if the lock is not installed properly and /or if any supplied component part is substituted with a foreign part. If the lock is used with a wall bumper, the warranty is null and void. If a doorstop is required, we recommend the use of a floor secured stop.

The environment and conditions of use determine the life of finishes on Kaba Access Control products. Finishes on Kaba Access Control products are subject to change due to wear and environmental corrosion. Kaba Access Control cannot be held responsible for the deterioration of finishes.

Authorization to Return Goods

Returned merchandise will not be accepted without prior approval. Approvals and Returned Goods Authorization Numbers (RGA Numbers) for Simplex are available through our Customer Service department in Winston-Salem, NC 800.849.8324. The serial number of a lock is required to obtain this RGA Number. The issuance of an RGA does not imply that a credit or replacement will be issued.

The RGA number must be included on the address label when material is returned to the factory. All component parts including latches and strikes (even if not inoperative) must be included in the package with return. All merchandise must be returned prepaid and properly packaged to the address indicated.

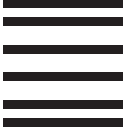

NO POSTAGE
NECESSARY
IF MAILED
IN THE
UNITED STATES

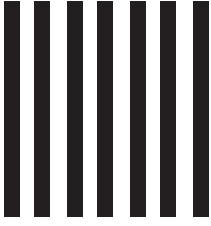

BUSINESS REPLY MAIL

FIRST-CLASS MAIL

PERMIT NO. 1563

WINSTON-SALEM, NC

POSTAGE WILL BE PAID BY ADDRESSEE

KABA ACCESS CONTROL
2941 INDIANA AVENUE
WINSTON-SALEM, NC 27199-3770



REGISTRATION CARD

Thank you for purchasing our product. In order to protect your investment and to enable us to better serve you in the future, please fill out this registration card and return it to Kaba Access Control, or register online at www.kabaaccess.com.

Name _____

Position _____

Company _____

Address _____

City _____

State _____ ZIP (Postal Code) _____ Country _____

Phone _____

Email _____

Name of Dealer Purchased From _____

Date of Purchase _____

Lock Model Number _____

This lock will be used in what type of facility?

- | | | |
|--|---|---|
| <input type="checkbox"/> Commercial Building | <input type="checkbox"/> Industrial/Manufacturing | <input type="checkbox"/> Airport |
| <input type="checkbox"/> College/University | <input type="checkbox"/> Government/Military | <input type="checkbox"/> School/Educational |
| <input type="checkbox"/> Hospital/Healthcare | <input type="checkbox"/> Other (please specify) _____ | |

What area is being secured with this lock? (e.g. Front Door, Common Door, Exercise Room)

This lock is:

- New Installation
- Replacing a conventional keyed lock
- Replacing a Kaba Mechanical Pushbutton Lock
- Replacing a Kaba Electronic Access Control
- Replacing a Keyless Lock other than Kaba

How did you learn about Kaba Access Control Pushbutton Locks?

- | | | | |
|--|---------------------------------------|---|---|
| <input type="checkbox"/> Advertisement | <input type="checkbox"/> Previous Use | <input type="checkbox"/> Internet/Web | <input type="checkbox"/> Another Use |
| <input type="checkbox"/> Locksmith | <input type="checkbox"/> Maintenance | <input type="checkbox"/> Training Class | <input type="checkbox"/> Other (please specify) |

What was your reason for buying this lock? _____

Who installed your lock?

- | | | |
|------------------------------------|--------------------------------------|--------------------------------|
| <input type="checkbox"/> Locksmith | <input type="checkbox"/> Maintenance | <input type="checkbox"/> Other |
|------------------------------------|--------------------------------------|--------------------------------|

Check here if you would like more information on Kaba Access Control locks.

B. OPERATION

All file guard locks are shipped with a preset factory combination: 1, 2, 3

B-1 Turn control knob LEFT (counterclockwise) to stop position, and release to clear chamber.

B-2 Press the CORRECT buttons in the PROPER order in your current combination. Release buttons after pressing each number in the combination. (For new units, current (factory) code is 1, 2, 3)

B-3 Turn control knob RIGHT (clockwise), to stop position. The bolt should now be retracted.

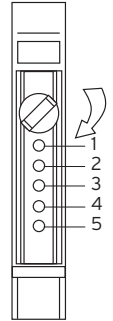
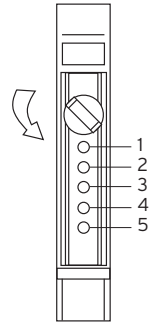

C. CHANGING THE COMBINATION

Note: Combination should be changed before lock is installed onto cabinet.

Select the number of buttons and the desired sequence (order) in which the buttons will be in your combination. Each number can only be used once. Two or more numbers can be set at one time, developing a different combination than if pushed individually.

C-1 Turn control knob LEFT (counterclockwise), to stop position, and release to clear chamber. Enter current combination by pressing the correct buttons in proper order. (For new units, current (factory) code is 1, 2, 3)

C-2 Through the round opening on the back side of the File Guard locking bar, push the combination change tab up.

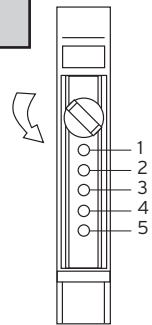

Combination change tab



PUSH ↑

Combination change tab access opening.



C-3 Turn control knob Left (counterclockwise), to stop position and release to clear the existing lock combination.

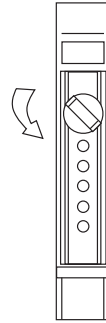

C-4 Press buttons in proper order for NEW combination. Press the buttons firmly to insure activation.
Record your new combination.

C-5 Turn control knob Right (clockwise) 90°, to stop position, to set the NEW combination.

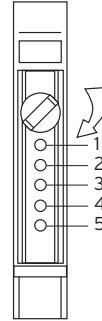

Note: If the lock opens without a combination being entered, the lock is in "0" code. A step was omitted during the process. Repeat Steps C-2 thru C-5.

D. INSTRUCTIONS FOR RESETTING AN UNKNOWN COMBINATION

Remove the push button unit from the file guard bar by removing the 2 screws on the back of the file guard bar. Set the bar aside. Remove the combination chamber from the lock held in by 2 screws.

To remove the 3-sided dust cover marked "Kaba Simplex," place the combination chamber in the position below.

D-1 Place a small screwdriver on the edge of the 3-sided dust cover and push down on the screwdriver. The cover should pop loose. Once it does, pull the cover off of the combination chamber.

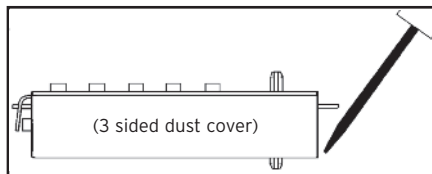

D-2 Hold the chamber in one hand by the screw tabs (b) on each end with the key-stems (c) facing you and the control shaft (d) at the bottom.

D-3 Using pliers or equivalent, rotate the control shaft (d) counterclockwise and release to clear the chamber.

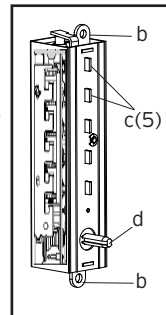

D-4 Look at the 5 code gears (e). If any code gear pockets (f) are already at the shear line (open position), ignore them. They are not used in the combination.

Note: Shear line (open position) references the "L" shaped feet already align with the mating gear pocket.

D-5 Find the code gear pocket/s (e) that is farthest away from the shear line (open position). Depress that key-stem/s (c) and release. If any digits in the combination were depressed together (at the same time), then they must also be depressed together to reset the combination.

D-6 Find the code gear pocket/s (e) that is the next farthest away from the shear line (open position). Depress that key-stem/s (c) and release.

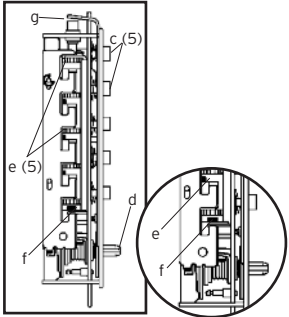

Note: If any of the code gear pockets travel past the shear line (open position), the key stems have been depressed in the wrong sequence. Start over at D-3.

D-7 Repeat step D-6 until all code gear pockets (e) are at the shear line (open position).

D-8 If all the code gear pockets (e) are not lined up at the shear line (open position), start over at step D-3.

D-9 Depress the lockout slide (g) at the top of the chamber and release. (looks like one end of a spark plug)

D-10 Using pliers or equivalent, rotate the control shaft (d) counter-clockwise to clear the chamber and release. The lockout slide (g) should pop out (button underneath will stay depressed bh8).

D-11 Depress the key-stem/s (c) that you want in the new combination, releasing each after it is depressed.

D-12 Once all the digits in the new combination have been depressed, with pliers or equivalent, rotate the control shaft (d) clockwise. The code change button (h) underneath the lockout slide (g), should pop up. The new combination is now set.

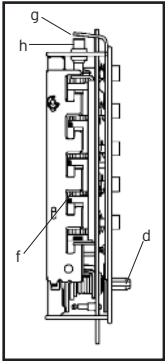

D-13 Look at the code gear pockets (e). The digits in the new combination should not be at the shear line (open position).

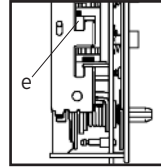

Reinstallation:

Replace the 3-sided dust cover marked "Kaba Simplex." Make sure the staked joints on both end plates fit through the slots on the dust cover. Stake the 2 end plate joints. Replace the combination chamber into the lock. Remount the lock housing assembly to locking bar.

Testing:

Enter the combination set during the reset process. Turn the thumbturn to the right (clockwise). The bolt should retract. If not, turn the thumbturn left (counterclockwise) and release. Enter the combination again and turn thumbturn to the right (clockwise). If still unsuccessful, start over at D-1.



Kaba Access Control

2941 Indiana Avenue

Winston-Salem, NC 27105 USA

Tel: 800.849.8324 or 336.725.1331

Fax: 800.346.9640 or 336.725.3269

www.kabaaccess.com

PKG3133 0609