

## WALL CONNECTING FRAME SYSTEM MR 22 AND MR 28

Comprising a frame profile (series-drilled), a clamping profile and two contact rubber extrusions (PVC, transparent).

These decorative and elegant frame solutions are suitable for both indoor and outdoor applications and are characterised by their remarkably easy installation.

The viewface width in the case of the MR 22 is a mere 22 mm and in the case of the MR 28 it is just 28 mm. Suitable for glass thicknesses of 8 and 10 mm. No load transfer by the profiles.

Can be readily removed and re-installed elsewhere.

The MR 28 features an additional screw-fixing channel for connecting angle brackets and enables combination with mullion profiles for the vertical connection of several glass panels and also abutment to frame systems AT 44 and AT 50.

Applications:

e.g. surrounding frame for toughened glass systems for fixing to walls and ceilings

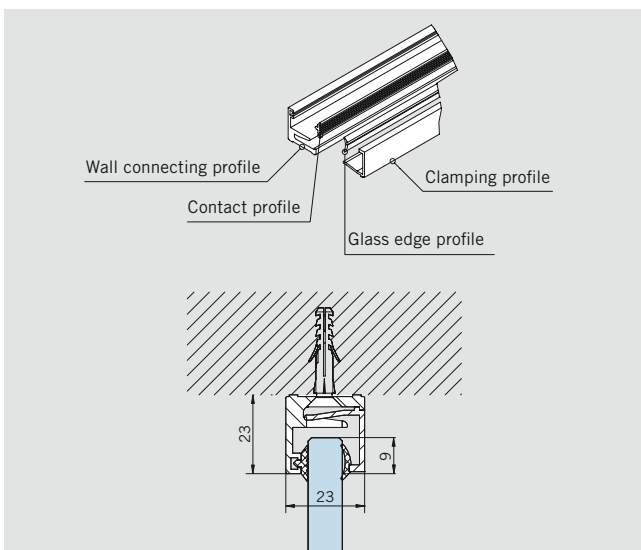

### Base profile

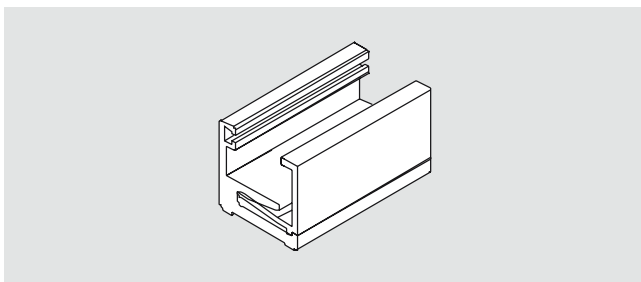

#### MR 22

in 6000 mm stock length,  
without PVC profile

**Art. No. 07.240**

Weight in kg/m:  
aluminium 0,648

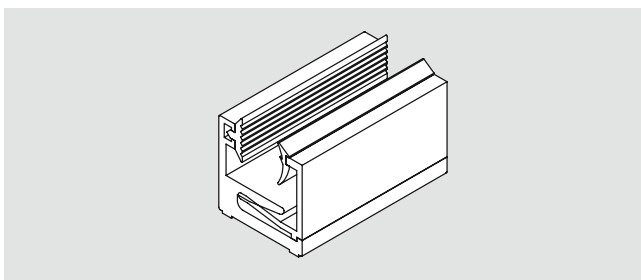

#### MR 28

in fixed length

**Art. No. 07.250**

Weight in kg/m:  
aluminium 0,648

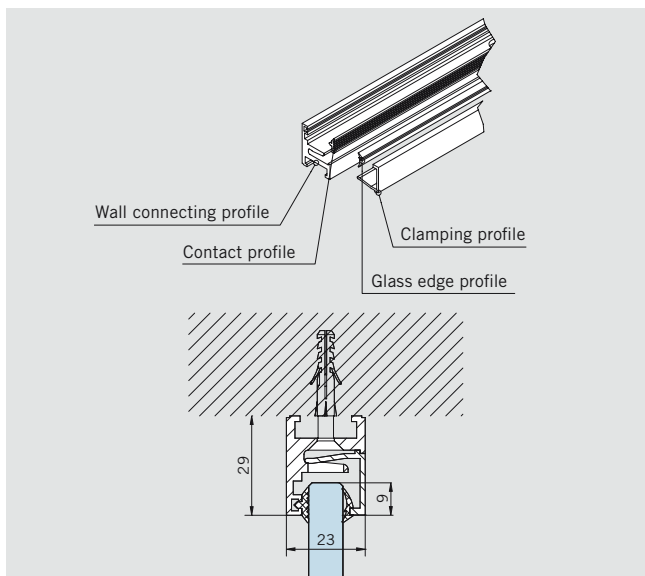

**Base profile**

**Attention:**

Profiles are only delivered with straight cuts. Allowances in lengths of profiles to ensure producibility of bevel cuts have to be planned by the customer. The georgian bar profile must be prepared in addition on both sides. Please consider installation instruction

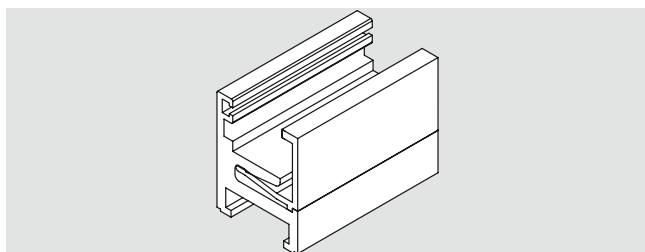

**MR 28**

in 6000 mm stock length, without PVC profile

**Art. No. 07.241**

Weight in kg/m:  
aluminium 0,802

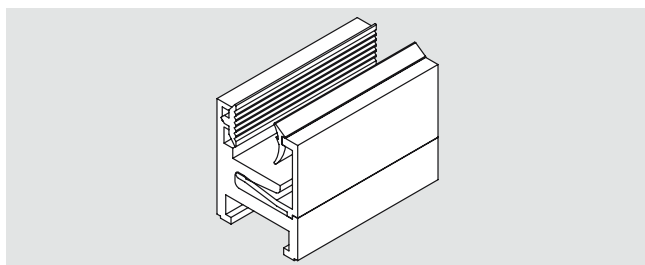

**MR 28**

in fixed length

**Art. No. 07.251**

Weight in kg/m:  
aluminium 0,802

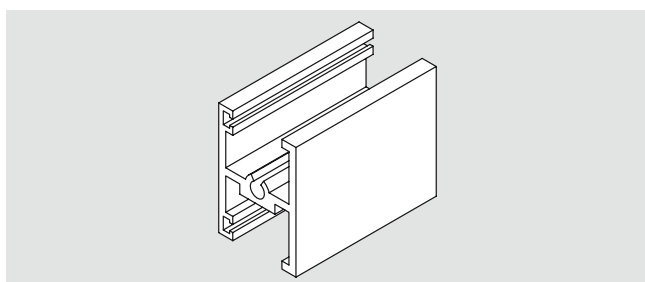

**Georgian bar profile MR 28**

in 6000 mm stock length, without PVC profile

**Art. No. 07.242**

Weight in kg/m:  
aluminium 0,542

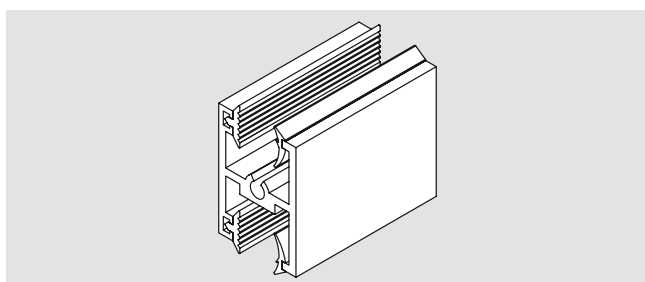

**Georgian bar profile MR 28**

in fixed length

**Art. No. 07.252**

Screws for fixation at M 28 base profile are not included in delivery.

**Recommendation:**  
counter sunk screw  
4.2 mm x 32 mm

Weight in kg/m:  
aluminium 0,542

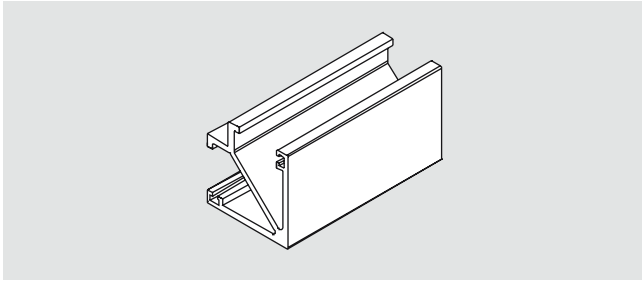

**MR 28 georgian bar profile  
90°**  
in 6000 mm stock length

**Art. No. 07.258**

Weight in kg/m:  
aluminium 0.598

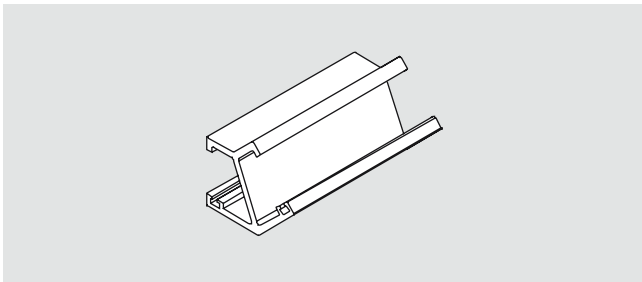

**MR 28 georgian bar profile  
135°**  
in 6000 mm stock length

**Art. No. 07.259**

Weight in kg/m:  
aluminium 0.466

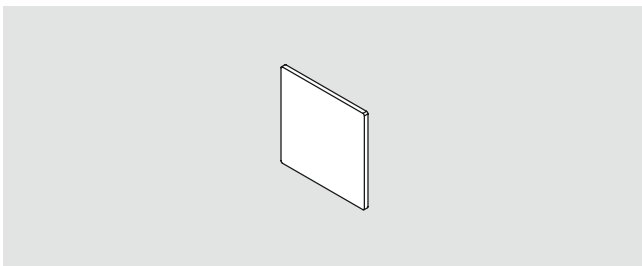

**End mounted plate MR 22**

**Art. No. 07.245**

Weight in kg/pc:  
aluminium 0,002

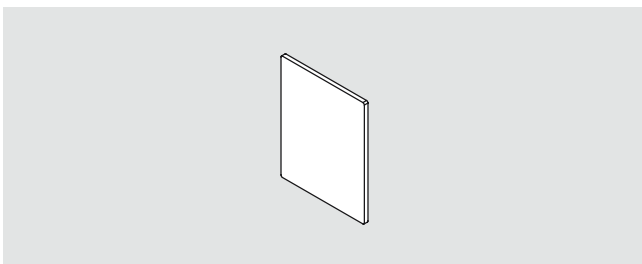

**End mounted plate MR 28**

**Art. No. 07.246**

Weight in kg/pc:  
aluminium 0,002

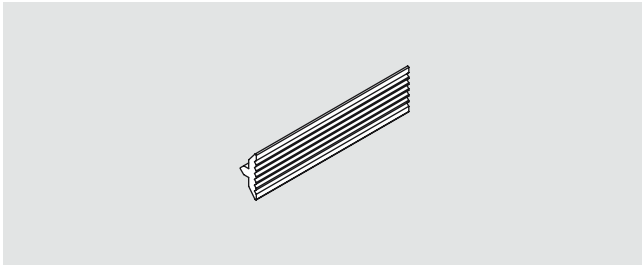

**Contact profile**  
2 mm thick, grey

fixed length  
stock length 50 m

**Art. No. 07.255**  
**Art. No. 07.265**

Weight in kg/m:  
PVC 0.023

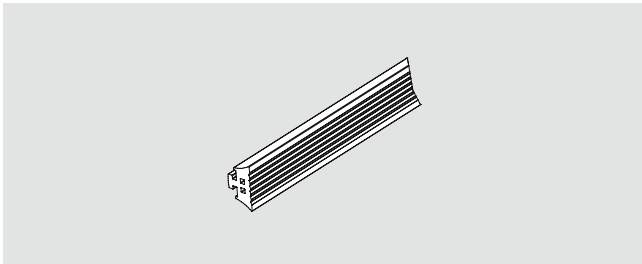

**Contact profile**  
4 mm thick, grey

fixed length  
stock length 50 m

**Art. No. 07.256**  
**Art. No. 07.266**

Weight in kg/m:  
PVC 0.037

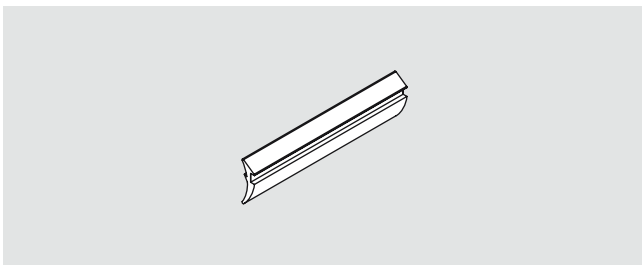

**Glass wedge profile**  
2 mm thick, grey

fixed length  
stock length 50 m

**Art. No. 07.253**  
**Art. No. 07.263**

Weight in kg/m:  
PVC 0.016

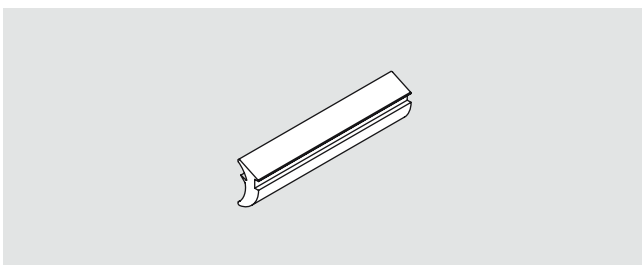

**Glass wedge profile**  
4 mm thick, grey

fixed length  
stock length 25 m

**Art. No. 07.254**  
**Art. No. 07.264**

Weight in kg/m:  
PVC 0.034

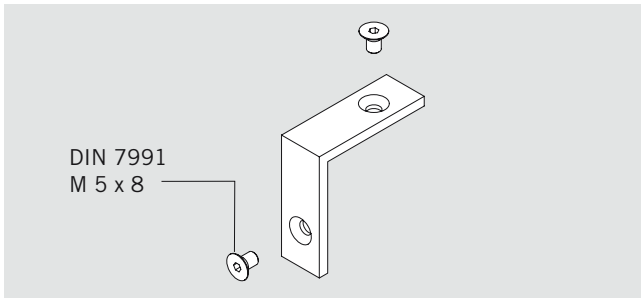

**Corner connection set MR 28,**  
4 pieces per set

**Art. No. 07.247**

Weight in kg/pc:  
aluminium 0,0021

8 screws DIN 7991  
M 5 x 8 included in scope of  
delivery

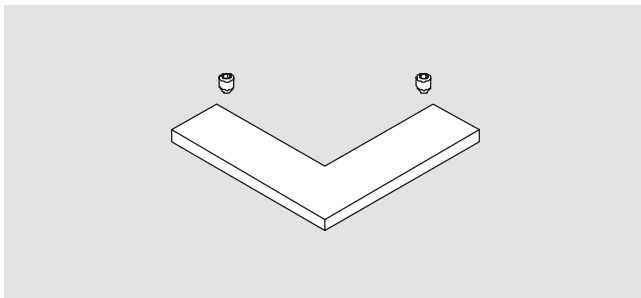

**Corner connection for MR 28**  
**georgian bar profil 90°**

**Art. No. 07.248**

2 grub screws DIN 916  
M 4 x 5 included in scope of  
delivery

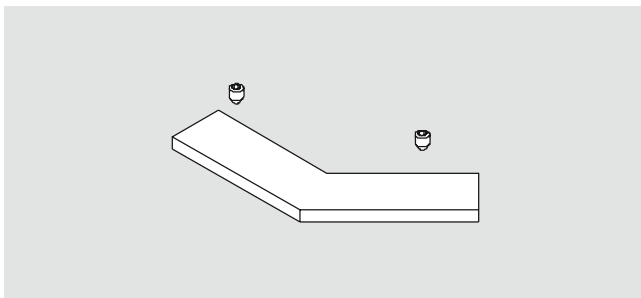

**Corner connection for MR 28**  
**georgian bar profil 135°**

**Art. No. 07.249**

2 grub screws DIN 916  
M 4 x 5 included in scope of  
delivery